

USER MANUAL **BLK-GLD** **STICKER SERIES**

Black and gold stickers for measuring convective and radiative heat flux separately

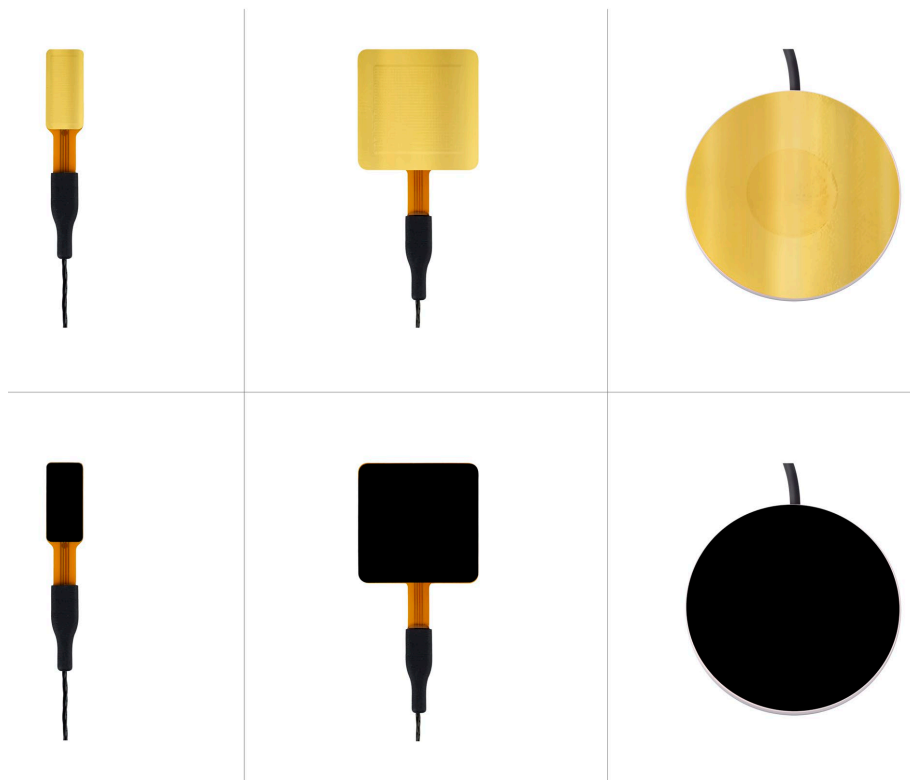

Cautionary statements

Cautionary statements are subdivided into four categories: danger, warning, caution and notice according to the severity of the risk.

 DANGER
Failure to comply with a danger statement will lead to death or serious physical injuries.

 WARNING
Failure to comply with a warning statement may lead to risk of death or serious physical injuries.

 CAUTION
Failure to comply with a caution statement may lead to risk of minor or moderate physical injuries.

NOTICE
Failure to comply with a notice may lead to damage to equipment or may compromise reliable operation of the instrument.

Contents

Cautionary statements	2
Contents	3
List of symbols	4
Introduction	5
1 Ordering and checking at delivery	8
1.1 Ordering BLK – GLD stickers	8
1.2 Included items	10
2 Instrument principle and theory	11
2.1 Introduction	11
2.2 Normal use: moderate-accuracy and comparative measurements	13
3 Advanced use: high-accuracy measurements	14
3.1 Introduction	14
3.2 Spectral properties of BLK and GLD stickers	14
3.3 BLK and GLD sensors on the same heat sink	16
3.4 BLK and GLD sensors at different temperatures	20
3.5 Surface temperature correction at high flux levels	21
3.6 Optional correction for sensor temperature dependence	23
3.7 Working with high colour temperature sources; the Sun, Xenon lamps	24
4 Examples of BLK and GLD in use	25
4.1 Outgoing radiation heat flux on metallic / reflective surfaces	25
4.2 Sources covering part of the sensor field of view; the view factor	26
4.3 Heat flux measurement to characterise ovens, thermal profiling	28
5 Specifications of BLK – GLD sticker series	32
5.1 Specifications of BLK – GLD stickers	32
5.2 Dimensions of BLK – GLD stickers	34
6 Installation of BLK – GLD sticker series	36
6.1 Application procedure	36
6.2 Site selection and sensor installation	38
7 Maintenance and trouble shooting	40
7.1 Recommended maintenance and quality assurance	40
7.2 Trouble shooting	42
7.3 Calibration and on-site checks	42
8 Appendices	43
8.1 Reflection versus wavelength and source temperature	43
8.2 EU declaration of conformity	46

List of symbols

Quantities

Heat flux
 Voltage
 Sensitivity
 Temperature
 Temperature dependence of sensitivity
 Thermal resistance per unit area
 Heat transfer coefficient by convection
 Area
 Reflection factor
 Absorbance
 Emissivity
 Stefan-Boltzmann constant: 5.67×10^{-8}
 Optical view factor
 Angle of incidence
 Solid angle

Symbol	Unit
Φ	W/m ²
U	V
S	V/(W/m ²)
T	°C or K
TD	%/K
R _{thermal,A}	K/(W/m ²)
C _{tr}	(W/m ²)/K
A	m ²
r	-
a	-
ε	-
σ	W/m ² ·K ⁴
f	-
θ	°
SA	sr

Subscripts

Property of sensor
 Property of heat sink
 Property of a radiative source
 Measured radiative heat flux
 Measured convective heat flux
 Sensor with black sticker
 Sensor with gold sticker
 Property of ambient air
 Property of ambient environment
 Total
 Emitted radiative flux
 Incoming radiative flux at the sensor position
 Absorbed radiative flux
 Reflected radiative flux

sensor
 sink
 source
 radiative
 convective
 BLK
 GLD
 air
 ambient
 total
 emitted
 incoming
 absorbed
 reflected

Abbreviations

Ultraviolet	UV
Visible light	VIS
Near-infrared	NIR
Far-infrared	FIR

Introduction

Heat flux measurement is a powerful tool to gain insights into processes involving thermal energy. Heat is transported to an object by convection and radiation. Studying thermal processes, the cause of temperature changes or heat transport, you may wish to separate radiative and convective heat flux. This is now possible with the BLK – GLD sticker series, designed to be used with a wide range of our market-leading heat flux sensors. The BLK black stickers absorb all radiation and are sensitive to both radiative and convective heat flux, while the GLD gold reflective stickers reflect all radiation and are sensitive to convective heat flux only. Applying BLK and GLD stickers, on two separate heat flux sensors, makes it possible to calculate the contributions of radiative and convective heat flux:

$$\Phi_{\text{radiative}} + \Phi_{\text{convective}} = \Phi_{\text{total}} = \Phi_{\text{BLK}}$$

$$\Phi_{\text{convective}} = \Phi_{\text{GLD}}$$

$$\Phi_{\text{radiative}} = \Phi_{\text{BLK}} - \Phi_{\text{GLD}}$$

BLK – GLD stickers have unique features and benefits:

- makes it possible to perform convective and radiative heat flux measurements
- available as accessory for the five models of the FHF05 series and HFP01 heat flux sensors
- designed to be applied by the user

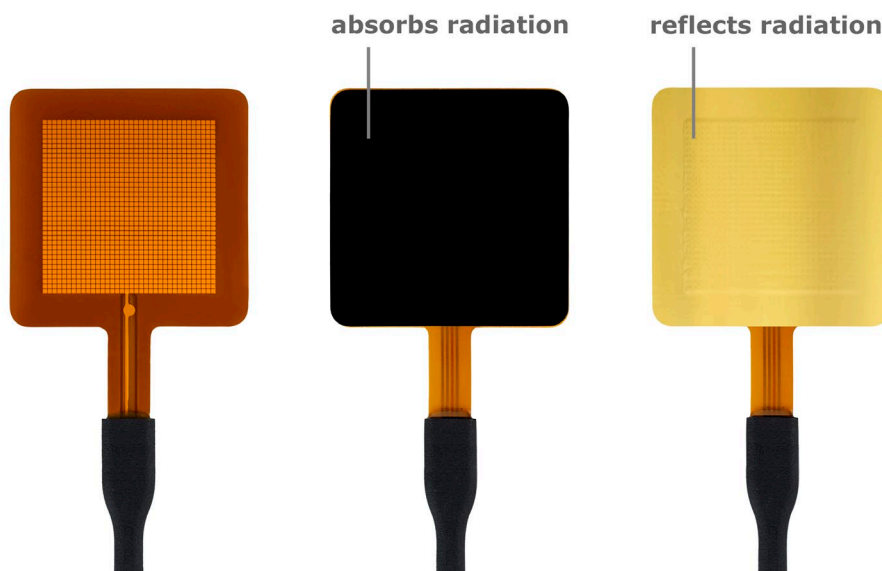

Figure 0.1 From left to right: model FHF05-50X50 heat flux sensor, FHF05-50X50 with BLK-50X50 sticker, and FHF05-50X50 with GLD-50X50 sticker. BLK – GLD stickers are also available for other dimensions of the FHF05 series and HFP01 heat flux sensors. The BLK black absorbing stickers will absorb all radiation and are sensitive to both radiative and convective heat flux, while the GLD gold reflective stickers reflect all radiation and are sensitive to convective heat flux only.



Figure 0.2 Working with BLK - GLD stickers: measuring the radiative and convective heat fluxes on an espresso machine.

BLK - GLD stickers are easy to use:

They are designed to be applied by the user but can optionally also be pre-applied at the factory. Applying a sticker to a heat flux sensor does not change the sensitivity of the sensor, so no additional calibration is required. Using the reliable measurement technology behind our heat flux sensors, separating convective and radiative heat flux has never been easier.



Figure 0.3 BLK - GLD sticker series is a range of accessories for use with Hukseflux heat flux sensors of the FHF05 series and HFP01. The stickers have matching sizes and are designed to be applied by the user to the sensor.

There is restriction to use BLK and GLD stickers: in particular if there is a notable amount of solar radiation, the GDL sticker will absorb a significant part of it.

NOTICE

Treat BLK and GLD stickers with care. Avoid abrasive action. Clean gently with soft cloth and if needed with demi-water. The gold layer of the GLD sticker is extremely thin and may easily be rubbed off.

NOTICE

The GLD sticker will not perfectly reflect radiation from sources with blackbody temperature higher than 4000 K. Solar radiation is in this category. When in doubt, consult this manual or Hukseflux.

See also:

- BLK – GLD sticker application [instruction video](#) on our YouTube channel
- [FHF05 series](#) general-purpose heat flux sensor
- [FHF05SC series](#) a self-calibrating version of the FHF05 series
- model [HFP01](#) for increased sensitivity
- heater [HTR02 series](#), for calibration and verification of performance of FHF-type sensors
- view our complete [range of heat flux sensors](#)



Figure 0.4 Overview of BLK-GLD stickers series: black absorbing stickers and gold reflective stickers matching FHF05 series and HFP01 heat flux sensors. They are designed to be applied by the user but can optionally also be pre-applied at the factory. The figure shows, from left to right, the stickers GLD and BLK on FHF05-10X10, FHF05-15X30, FHF05-50X50, FHF05-15X85 and FHF05-85X85. BLK-GLD sticker series is also available for model HFP01 and FHF05SC series.

1 Ordering and checking at delivery

1.1 Ordering BLK – GLD stickers

The BLK – GLD sticker series is a range of accessories for use with Hukseflux heat flux sensors of FHF05(SC) series and HFP01.

The ordering codes of the different versions in the series are BLK-10X10, BLK-15X30, BLK-50X50, BLK-15X85, BLK-85x85, BLK-80, GLD-10X10, GLD-15X30, GLD-50X50, GLD-15X85, GLD-85X85 and GLD-80.

Table 1.1.1 *Overview of versions in the BLK – GLD sticker series*

BLK versions	
BLK-10X10	Black absorbing sticker to measure convective + radiative heat flux, to be used with FHF05(SC)-10X10 heat flux sensors
BLK-15X30	Black absorbing sticker to measure convective + radiative heat flux, to be used with FHF05(SC)-15X30 heat flux sensors
BLK-50X50	Black absorbing sticker to measure convective + radiative heat flux, to be used with FHF05(SC)-50X50 heat flux sensors
BLK-15X85	Black absorbing sticker to measure convective + radiative heat flux, to be used with FHF05(SC)-15X85 heat flux sensors
BLK-85X85	Black absorbing sticker to measure convective + radiative heat flux, to be used with FHF05(SC)-85X85 heat flux sensors
BLK-80	Black absorbing sticker to measure convective + radiative heat flux, to be used with HFP01 heat flux sensor
GLD versions	
GLD-10X10	Gold reflective sticker to measure convective heat flux only, to be used with FHF05(SC)-10X10 heat flux sensors
GLD-15X30	Gold reflective sticker to measure convective heat flux only to be used with FHF05(SC)-1530 heat flux sensors
GLD-50X50	Gold reflective sticker to measure convective heat flux only, to be used with FHF05(SC)-50X50 heat flux sensors
GLD-15X85	Gold reflective sticker to measure convective heat flux only, to be used with FHF05(SC)-15X85 heat flux sensors
GLD-85X85	Gold reflexive sticker to measure convective heat flux only, to be used with FHF05-85X85 heat flux sensors
GLD-80	Gold reflective sticker to measure convective heat flux only, to be used with HFP01 heat flux sensor

A common option is:

- pre-application of the sticker to the sensor(s) of your choice at the factory

When opting for pre-application at the factory, please use the following ordering code:
product code sensor with cable length indicated + product code sticker

example: HFP01-05-GLD-80

for model HFP01 with 5 meters of cable and a pre-applied gold sticker

1.2 Included items

Arriving at the customer, the delivery should include:

- BLK – GLD sticker version(s) as ordered
- application procedure instruction sheet
- prostrated IPA (Isopropyl Alcohol) wipe

See the instruction sheet included with your delivery, the instruction movie on our YouTube channel or Section 4.1 of this manual for instructions how to apply the BLK – GLD stickers to your sensor.

When opting for pre-applied BLK – GLD stickers, the delivery should include:

- heat flux sensor with sticker applied, with cable of the length as ordered
- product certificate matching the instrument serial number

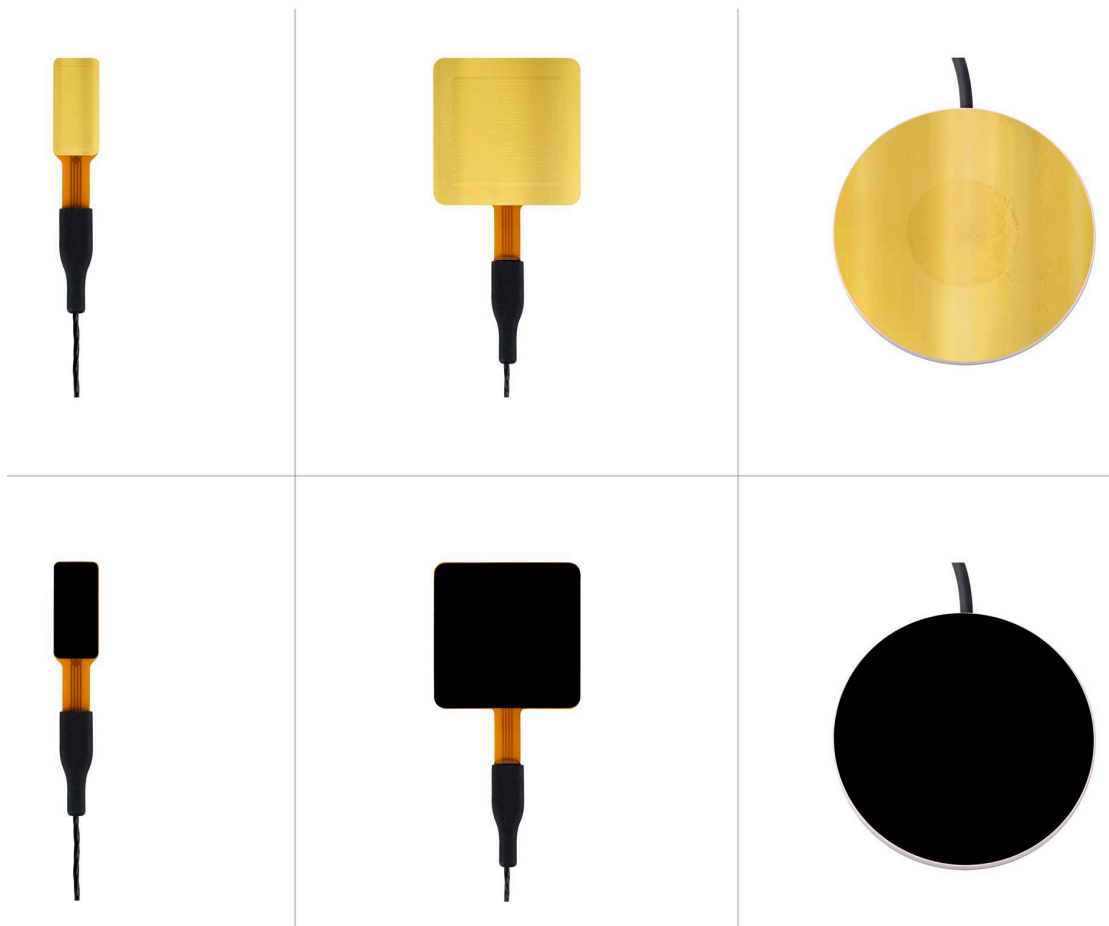

Figure 1.2.1 *GLD and BLK stickers pre-applied to their matching sensors at the factory*

2 Instrument principle and theory

2.1 Introduction

BLK and GLD stickers series are accessories to FHF05 series and HFP01 heat flux sensors. These stickers allow the heat flux sensors to be used to separately measure radiative and convective heat flux.

As a first approximation, BLK black stickers absorb all radiation, as Figure 2.1 shows.

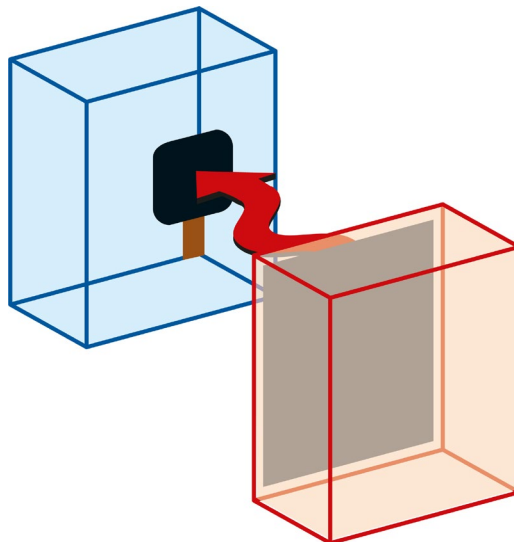

Figure 2.1.1 *BLK black stickers absorb all radiation*

In contrast to BLK black stickers, GLD gold stickers as a first approximation reflect all radiation.

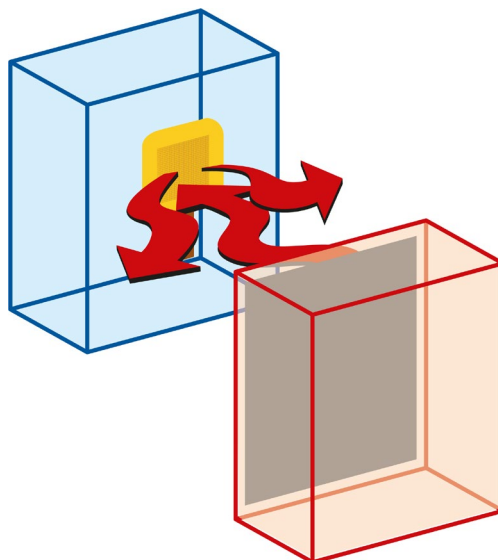

Figure 2.1.2 *GLD gold stickers reflect all radiation*

BLK black stickers are sensitive both to radiative and convective heat flux, whereas GLD gold stickers, reflecting all radiation, are sensitive to convective heat flux only. See Figure 2.1.3.

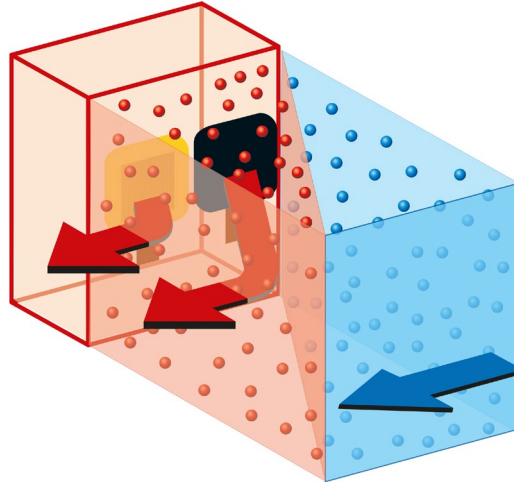

Figure 2.1.3 Both BLK and GLD stickers are sensitive to convective heat flux

Summarising, radiative and convective heat flux are absorbed by the black sticker. The absorbed heat flows through the heat flux sensor, creating a temperature difference across the thermopile detector inside the heat flux sensor. This thermopile generates a small voltage proportional to the sum of the radiative and convective heat flux.

Radiative heat flux is reflected by the gold sticker, convective heat flux is absorbed. The absorbed heat flows through the heat flux sensor, generating a small voltage proportional to the convective heat flux.

The proportionality factor, the ratio of heat flux sensor output voltage to heat flux, is called the sensitivity S in $V/(W/m^2)$. This is determined individually for the heat flux sensor by calibration and reported on its product certificate.

Applying a sticker to a heat flux sensor does not change the sensitivity of the heat flux sensor.

2.2 Normal use: moderate-accuracy and comparative measurements

As a first approximation, you may assume that both sensors are at the same temperature and have perfect absorption and emission. This approach leads to moderate-accuracy results. These may be sufficient for the average user.

This moderate-accuracy approach is also often used to compare two situations, for example with a source switched [on] or [off]. Furthermore, it is useful to estimate orders of magnitude of heat flux as a starting point for high-accuracy measurements.

For moderate-accuracy measurements the following formulas are used:

$$\Phi_{\text{radiative}} + \Phi_{\text{convective}} = \Phi_{\text{total}} = \Phi_{\text{BLK}} \quad (2.1.1)$$

$$\Phi_{\text{convective}} = \Phi_{\text{GLD}} \quad (2.1.2)$$

$$\Phi_{\text{radiative}} = \Phi_{\text{BLK}} - \Phi_{\text{GLD}} \quad (2.1.3)$$

The heat flux Φ in W/m^2 passing through- and measured by a heat flux sensor is

$$\Phi = U/S \quad (2.1.4)$$

where [U] is the heat flux sensor voltage output, and [S] the sensitivity found on the sensor calibration certificate.

Chapter 3 explains what should be done to attain a high-accuracy measurement.

3 Advanced use: high-accuracy measurements

3.1 Introduction

The following sections explain what should be done to attain a high-accuracy measurement with BLK and GLD stickers.

For high accuracy measurement it is essential to understand that:

- absorption and reflection of both BLK and GLD stickers may not be perfect
- a sensor with a BLK black sticker not only receives radiation, but also emits radiation depending on its own temperature. What is measured is the net result of incoming and emitted radiation
- the surface temperature of a sensor is not the same as the measured temperature. The difference between the measured sensor body and heat sink temperature depends on the heat flux. The difference can be calculated from temperature, heat flux and thermal resistance of the sensor. At high heat fluxes this temperature difference is significant.
- the sensitivity of a heat flux sensor is not a constant. It changes with temperature. Calibration is performed at 20 °C. At operating temperatures far away from the calibration temperature, you may compensate for this effect.
- radiation of high colour-temperature sources is not perfectly reflected by the GLD sensor

Section 3.2 gives more details on the BLK and GLD spectral properties. The further sections treat typical mathematical treatment of measurement results to compensate for the above effects.

3.2 Spectral properties of BLK and GLD stickers

In high accuracy measurement you may correct for non-perfect absorption and emission. This section gives the numbers to work with. See also the appendix on the subject.

3.2.1 Reflection

In an ideal scenario, a black sticker reflects no radiation across all wavelengths and a gold sticker reflects all radiation across all wavelengths. In reality, the reflection of both stickers depends on the wavelength of the incoming radiation.

The BLK black sticker has an average reflection of 3 % ($r_{\text{BLK}} = 0.03$) in the UV, visible, near-infrared and far-infrared spectrum.

The GLD gold sticker has a reflection of about 35 % ($r_{\text{GLD}} = 0.35$) in the UV spectrum, which increases through the visible spectrum to an average reflection value of 98 % ($r_{\text{GLD}} = 0.98$) in the near-infrared and the far-infrared.

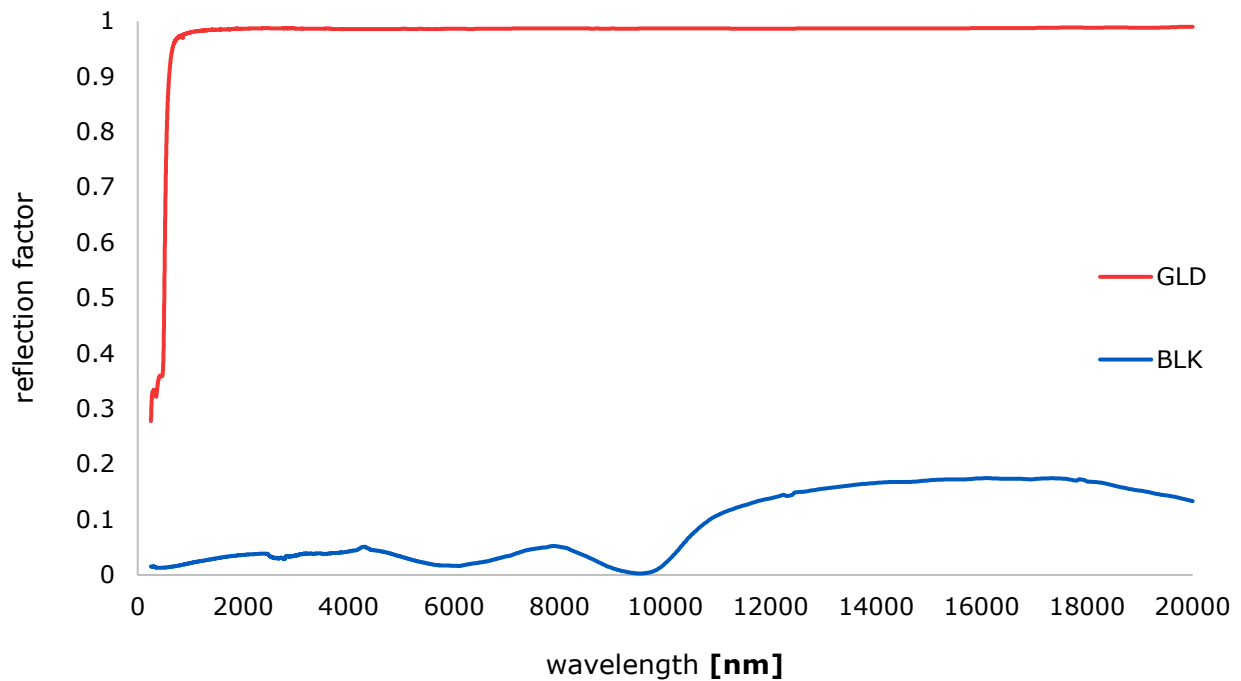

Figure 3.2.1.1 BLK and GLD reflection factors as a function of wavelength

Typical values of the average reflection factors for common radiation sources are given in table 2.2.1.1.

For more details on spectral properties of the stickers, see the Appendix on the subject.

Table 3.2.1.1 Typical reflection factor for common radiation sources

RADIATION SOURCE	r_{BLK}	r_{GLD}
UV radiation	0.02	0.35
Solar radiation, Xenon lamps (colour temperature 6000 K)	0.02	0.80
Halogen and infrared lamps, industrial heaters (colour temperature < 4000 K)	0.03	0.97
Low temperature infrared sources such as radiant heaters, stoves, 300 to 600 °C	0.05	0.99
Objects at room temperature, - 40 to + 70 °C	0.11	0.99

3.2.2 absorption and emissivity

In certain applications, absorption and emissivity are the relevant spectral properties instead of reflection.

Absorption α is the amount of energy absorbed by an object.

$$\alpha_{\text{BLK}} = 1 - r_{\text{BLK}}$$

$$\alpha_{\text{GLD}} = 1 - r_{\text{GLD}}$$

Emissance is the amount of thermal energy emitted by an object. Numerically, emissivity is the same as absorption.

$$\epsilon_{\text{BLK}} = \alpha_{\text{BLK}}$$

$$\epsilon_{\text{GLD}} = \alpha_{\text{GLD}}$$

Table 3.2.2.1 Typical absorption factors for common radiation sources

RADIATION SOURCE	α_{BLK}	α_{GLD}
UV radiation	0.98	0.65
Solar radiation, Xenon lamps (colour temperature 6000 K)	0.98	0.20
Halogen and infrared lamps, industrial heaters (colour temperature < 4000 K)	0.97	0.03
Low temperature infrared sources such as radiant heaters, stoves, 300 to 600 °C	0.95	0.01
Objects at room temperature, - 40 to + 70 °C	0.89	0.01

3.3 BLK and GLD sensors on the same heat sink

If possible, we recommend mounting the two sensors, BLK and GLD, on the same heat sink. This makes analysis easy because they then have - at least approximately, which is sufficient - the same temperature, and thus:

$$T_{\text{BLK}} = T_{\text{GLD}} \tag{3.3.1}$$

To measure radiative and convective heat flux, preferably:

- apply a BLK black sticker on a first heat flux sensor
- apply a GLD gold sticker on another heat flux sensor
- place the two heat flux sensors side by side, on the same heat sink so that they have the same heat sink (and sensor) temperature.
- a heat sink may be a metal plate, for example an aluminium plate of at least 1 mm thickness, or, in case a larger heat capacity is required, a thicker plate. We then assume there is no significant temperature difference of the heat sink between sensors (difference < 2 °C)

Measure:

- T_{amb} , ambient air temperature
- T_{GLD} , the heat sink temperature
- Φ_{BLK} , heat flux measured by the black heat flux sensor (output voltage divided by sensitivity)
- Φ_{GLD} , heat flux measured by the gold heat flux sensor (output voltage divided by sensitivity)

Typical boundary conditions to keep in mind are:

- valid measurements require steady state conditions: temperature and flux do not change
- no solar radiation or other sources with high colour temperature (see the section on working with high temperature sources / solar radiation)
- heat fluxes below a level that surface temperature significantly increases (see the section on correction of sensor surface temperature)
- spectral corrections are made based on the tables in the section about spectral properties)
- sensor temperatures at a level that temperature dependence is not corrected (see appendix on temperature dependence)

Applying a sticker does not alter the working principle of the heat flux sensor. The original sensitivity S , as specified on the sensor calibration certificate, is still valid.

For most VIS, IR and FIR radiation sources the GLD sticker is a perfect reflector. This does not apply to solar and Xenon lamp sources (see tables in 3.2). In case the sources have a low colour temperature, lower than 1000 °C, we assume that the reflection factor of GLD, while actually 0.99, is 1. See the section on sources with high colour temperature and the appendix on reflection and absorption how to deal with exceptional sources.

$$r_{GLD} = 1 \quad (3.3.2)$$

The heat flux Φ in W/m^2 passing through- and measured by a heat flux sensor is

$$\Phi = U/S \quad (3.3.3)$$

where $[U]$ is the heat flux sensor voltage output, and $[S]$ the sensitivity found on the sensor calibration certificate.

3.3.1 Measurement of convective flux

The purpose is to calculate the convective heat flux $\Phi_{\text{convective}}$:

- transferred by ambient air at a certain temperature and speed
- to an object at the heat flux sensor location
- to an object at the heat flux sensor temperature
- to an object in the heat flux sensor plane (same surface orientation)

The heat flux due to convection is measured by the GLD sensor.

$$\Phi_{\text{convective}} = \Phi_{\text{GLD}} = U_{\text{GLD}}/S_{\text{GLD}} \quad (3.3.1.1)$$

3.3.2 Characterising a convective source: T_{air} and heat transfer coefficient C_{tr}

Properties of a convective source properties are the convective ambient air temperature T_{air} and the convective heat transfer coefficient C_{tr} . Knowing C_{tr} , the convective heat transfer to a similarly oriented surface in the same airflow may be calculated.

Note that the convective heat transfer coefficient C_{tr} is not a function of the sensor temperature, because the $\Phi_{\text{convective}}$ is proportional to the difference ($T_{\text{air}} - T_{\text{GLD}}$). C_{tr} is a function of:

- air speed and
- the interaction of the sensor surface with the air (orientation of the surface).

$$C_{\text{tr}} = \Phi_{\text{convective}}/(T_{\text{air}} - T_{\text{GLD}}) \quad (3.3.2.1)$$

Expected measured values of the heat transfer coefficient for air are between 5 to 20 W/(m²·K) for natural thermal convection and up to 100 W/(m²·K) for forced convection.

The convective heat transfer to a similarly oriented surface in the same airflow is:

$$\Phi_{\text{convective, surface}} = C_{\text{tr}} \cdot (T_{\text{air}} - T_{\text{surface}}) \quad (3.3.2.2)$$

3.3.3 Measurement of incoming radiative flux

The purpose is to calculate the radiative heat flux Φ_{incoming}

- emitted by the source
- incoming to an object at the heat flux sensor location
- to an object in the heat flux sensor plane (same surface orientation)

As a first approximation we assume that the heat transfer by convection to the BLK and GLD sensors is identical, because their surface temperatures are the same, see 2.3.1.

$$\Phi_{\text{convective}} = \Phi_{\text{convective BLK}} = \Phi_{\text{convective GLD}} \quad (3.3.3.1)$$

The measured radiative flux Φ_{BLK} is a net heat flux consisting of incoming flux from the source, corrected for the absorption of the BLK coating $\alpha_{\text{BLK, incoming}}$ for incoming radiation Φ_{incoming} from the source at T_{source} minus the (blackbody) radiation emitted by the sensor at T_{BLK} , corrected for the emission of the BLK coating, $\epsilon_{\text{BLK, emitted}}$.

The net heat flux by radiation as measured by the BLK sensor

$$\Phi_{\text{radiative BLK}} = \Phi_{\text{BLK}} - \Phi_{\text{convective GLD}} = (U_{\text{BLK}}/S_{\text{BLK}}) - (U_{\text{GLD}}/S_{\text{GLD}}) \quad (3.3.3.2)$$

and

$$\Phi_{\text{radiative BLK}} = \alpha_{\text{BLK, incoming}} \cdot \Phi_{\text{incoming}} - \sigma \cdot \epsilon_{\text{BLK, emitted}} \cdot (T_{\text{BLK}} + 273)^4 \quad (3.3.3.3)$$

This gives us the following formula to calculate the incoming flux:

$$\Phi_{\text{incoming}} = (\Phi_{\text{radiative BLK}} + \sigma \cdot \epsilon_{\text{BLK, emitted}} \cdot (T_{\text{BLK}} + 273)^4) / \alpha_{\text{BLK, incoming}} \quad (3.3.3.4)$$

3.3.3.1 Example 1: working around room temperature:

Consider the following boundary conditions:

$$-40 \text{ }^\circ\text{C} < T_{\text{BLK}}, T_{\text{source}} < 70 \text{ }^\circ\text{C} \quad (3.3.3.1.1)$$

We assume (see appendix on absorption and reflection):

$$\epsilon_{\text{BLK, emitted}} = \alpha_{\text{BLK, incoming}} = 0.89 \quad (3.3.3.1.2)$$

so that

$$\Phi_{\text{incoming}} = 1.12 \cdot \Phi_{\text{radiative BLK}} + \sigma \cdot (T_{\text{BLK}} + 273)^4 \quad (3.3.3.1.3)$$

3.3.3.2 Example 2: sensor at room temperature and a uniform infra-red source

Consider the following boundary conditions:

$$-40 \text{ }^\circ\text{C} < T_{\text{BLK}} < 70 \text{ }^\circ\text{C}, \quad (3.3.3.2.1)$$

$$300 \text{ }^\circ\text{C} < T_{\text{source}} < 600 \text{ }^\circ\text{C} \quad (3.3.3.2.2)$$

We assume:

$$\varepsilon_{\text{BLK, emitted}} = 0.89 \quad (3.3.3.2.3)$$

$$\alpha_{\text{BLK, incoming}} = 0.95 \quad (3.3.3.2.4)$$

and

$$\Phi_{\text{incoming}} = (1.05 \cdot \Phi_{\text{radiative BLK}} + 0.94 \cdot \sigma \cdot (T_{\text{BLK}} + 273)^4) \quad (3.3.3.2.5)$$

3.3.4 Characterising a radiative source: $T_{\text{blackbody}}$ equivalent blackbody temperature

The equivalent blackbody source temperature assumes that the heat flux sensors face

- an imaginary, uniform blackbody source
- over its full 180° field of view angle (or more correctly: 2π sr solid angle)
- with an emission of 1

$$\varepsilon_{\text{source}} = 1 \quad (3.3.4.1)$$

The heat exchange is described by:

$$\sigma \cdot \varepsilon_{\text{source}} \cdot (T_{\text{blackbody}} + 273)^4 = (\Phi_{\text{radiative}} + \sigma \cdot \varepsilon_{\text{BLK, emitted}} \cdot (T_{\text{BLK}} + 273)^4) / \alpha_{\text{BLK, incoming}} \quad (3.3.4.2)$$

The equivalent blackbody source temperature is:

$$T_{\text{blackbody}} = ((\Phi_{\text{radiative}} + \sigma \cdot \varepsilon_{\text{BLK, emitted}} \cdot (T_{\text{BLK}} + 273)^4) / (\sigma \cdot \varepsilon_{\text{source}} \cdot \alpha_{\text{BLK, incoming}}))^{1/4} - 273 \quad (3.3.4.3)$$

3.4 BLK and GLD sensors at different temperatures

In case T_{BLK} and T_{GLD} differ by more than 2°C , this may have a significant impact on convective exchange:

$$|T_{\text{BLK}} - T_{\text{GLD}}| > 2 \quad (3.4.1)$$

equation 3.3.3.2 must be corrected for differences in convective heat flux:

$$\begin{aligned} \Phi_{\text{radiative}} &= \Phi_{\text{BLK}} - \Phi_{\text{convective GLD}} \\ &= (U_{\text{BLK}}/S_{\text{BLK}}) - (U_{\text{GLD}}/S_{\text{GLD}}) \cdot ((T_{\text{air}} - T_{\text{BLK}})/(T_{\text{air}} - T_{\text{GLD}})) \end{aligned} \quad (3.4.2)$$

From then on, the other equations of 3.3.3 may be used, possibly with the optional corrections of 3.5 and 3.6.

3.5 Surface temperature correction at high flux levels

A similar correction as in 3.4 should also be considered when there is a large heat flux. In that case the sensor surfaces may be hotter than the temperature measurement. The correction depends on the heat flux Φ through the sensor and on the thermal resistance, $R_{\text{thermal,A}}$, between the point at which the temperature is measured to the sensor surface. Taking the BLK sensor as an example:

$$T_{\text{BLK, corrected}} = T_{\text{BLK}} + \Phi_{\text{BLK}} \cdot R_{\text{thermal,A, BLK}} \quad (2.5.1)$$

$$= T_{\text{BLK}} + (U_{\text{BLK}}/S_{\text{BLK}}) \cdot R_{\text{thermal,A, BLK}} \quad (2.5.2)$$

As in 3.4 we recommend correction if the difference between the corrected and measured temperature is more than 2 °C.

Use correction if:

$$|(U_{\text{BLK}}/S_{\text{BLK}}) \cdot R_{\text{thermal,A, BLK}}| > 2 \quad (2.5.3)$$

3.5.1 Example: high heat flux correction with FHF05 series

A FHF05 model with a BLK or GLD sticker the thermal resistance is:

$$R_{\text{thermal,A}} = R_{\text{thermal,A, sensor}} + R_{\text{thermal,A, sticker}} = (11 + R_{\text{thermal,A, sticker}}) \times 10^{-4} \quad (3.5.1.1)$$

The location of temperature in the sensor is close to the surface where the sticker is applied to. Roughly, this is at 1/6th of the total sensor thickness (0.4×10^{-3} m). The total thermal resistance of the sensor is: $R_{\text{thermal,A, sensor}} = 11 \text{ K/(W/m}^2\text{)}$. To account for the location of the temperature probe, a value of $R_{\text{thermal,A, sensor temp location}} = 2 \text{ K/(W/m}^2\text{)}$ is taken.

The thermal resistance of the stickers is: $R_{\text{thermal,A, sticker BLK}} = 10 \times 10^{-4} \text{ K/(W/m}^2\text{)}$ and $R_{\text{thermal,A, sticker GLD}} = 3.5 \times 10^{-4} \text{ K/(W/m}^2\text{)}$.

For a FHF05 model with a BLK sticker, the thermal resistance between the front surface and the location of the thermocouple is:

$$R_{\text{thermal,A, sensor with BLK}} = (2 + 10) \times 10^{-4} \quad (3.5.1.2)$$

And for a FHF05 model with a GLD sticker, the thermal resistance between the front surface and the location of the thermocouple is:

$$R_{\text{thermal,A, sensor with GLD}} = (2 + 3.5) \times 10^{-4} \quad (3.5.1.3)$$

And the corrected temperature for the sensor with BLK sticker becomes

$$T_{\text{BLK, corrected}} = T_{\text{BLK}} + 12 \times 10^{-4} \cdot \Phi_{\text{BLK}} \quad (3.5.1.4)$$

$$= T_{\text{BLK}} + 12 \times 10^{-4} \cdot (U_{\text{BLK}}/S_{\text{BLK}}) \quad (3.5.1.5)$$

The corrected temperature for the sensor with GLD sensor becomes

$$T_{\text{GLD, corrected}} = T_{\text{GLD}} + 5.5 \times 10^{-4} \cdot \Phi_{\text{GLD}} \quad (3.5.1.6)$$

$$= T_{\text{GLD}} + 5.5 \times 10^{-4} \cdot (U_{\text{GLD}}/S_{\text{GLD}}) \quad (3.5.1.7)$$

For FHF05 we recommend correcting if:

$$12 \times 10^{-4} \cdot (U_{\text{BLK}}/S_{\text{BLK}}) > 2 \text{ } ^\circ\text{C} \quad (3.5.1.8)$$

$$5.5 \times 10^{-4} \cdot (U_{\text{GLD}}/S_{\text{GLD}}) > 2 \text{ } ^\circ\text{C} \quad (3.5.1.9)$$

or

$$\Phi_{\text{BLK}} > 1667 \text{ W/m}^2 \quad (3.5.1.10)$$

$$\Phi_{\text{GLD}} > 3635 \text{ W/m}^2 \quad (3.5.1.11)$$

In that case 3.3.3.2 becomes:

$$\begin{aligned} \Phi_{\text{radiative}} &= \Phi_{\text{BLK}} - \Phi_{\text{convective GLD}} \\ &= (U_{\text{BLK}}/S_{\text{BLK}}) - (U_{\text{GLD}}/S_{\text{GLD}}) \cdot ((T_{\text{air}} - T_{\text{BLK, corrected}})/(T_{\text{air}} - T_{\text{GLD}})) \end{aligned} \quad (3.5.1.12)$$

3.6 Optional correction for sensor temperature dependence

The sensitivity of a heat flux sensor depends on the temperature of the sensor. For example, the temperature dependence of the FHF05 series is specified as $< 0.2 \text{ \%/}^\circ\text{C}$. At higher temperatures, sensors usually are more sensitive. The order of magnitude is the same for other sensor models. See the product manuals for up-to-date estimates of temperature dependence for your sensor model.

The calibration reference temperature for Hukseflux sensors is $20 \text{ }^\circ\text{C}$.

Temperature dependence may be corrected. This is worthwhile only if the error is of the same order as calibration uncertainty, i.e., correction is recommended only if the correction $> 4 \text{ \%}$.

Apply corrections in case:

$$T_{\text{sensor}} < 0 \text{ }^\circ\text{C}, \quad (3.6.1)$$

or

$$T_{\text{sensor}} > 40 \text{ }^\circ\text{C} \quad (3.6.2)$$

3.6.1 Correction of temperature dependence of the FHF05 series

To correct for the temperature dependence of the sensitivity of sensor model FHF05, use the measurement function:

$$\Phi = U / (S \cdot (1 + 0.002 \cdot (T_{\text{sensor}} - 20))) \quad (3.6.1.1)$$

with Φ the heat flux in W/m^2 , U the sensor voltage output in V , S the sensitivity in $\text{V}/(\text{W/m}^2)$ at $20 \text{ }^\circ\text{C}$ and T_{sensor} the sensor temperature.

S is shown on the product certificate and with some models on the sensor itself.

3.7 Working with high colour temperature sources; the Sun, Xenon lamps

The colour temperature of solar radiation and of Xenon lamps is around 6000 K. For this spectrum, the GLD sticker no longer is a perfect reflector.

Heat flux of a direct solar beam on a clear sunny day may be in the order of 1000 W/m².

The absorption of GLD is 20 %, that of BLK 98 %, see section 2.2.

To correct for incoming solar radiation, use a pyranometer mounted in the same plane as the heat flux sensor to correct the data. A pyranometer measures the solar heat flux Φ_{solar} in W/m².

If a pyranometer is not available, Φ_{solar} may be estimated by carrying out an experiment shading and unshading the black sensor, as described in section 4.2.

Equation 3.3.1.1 is then corrected:

$$\Phi_{\text{convective}} = \Phi_{\text{GLD}} - 0.20 \cdot \Phi_{\text{solar}} \quad (3.7.1)$$

$$\Phi_{\text{radiative BLK}} = \Phi_{\text{BLK}} - \Phi_{\text{convective}} - 0.98 \cdot \Phi_{\text{solar}} \quad (3.7.2)$$

4 Examples of BLK and GLD in use

4.1 Outgoing radiation heat flux on metallic / reflective surfaces

Every object emits radiation. Only very hot objects, hotter than 400 °C, emit radiation that is visible to the eye. Although not visible, heat flux sensors with BLK stickers emit a significant amount of radiative energy too, while GLD stickers have a low emission so that the emitted radiation is negligible.

In general: when performing measurements of emitted radiation from a surface, use a heat flux sensor with a sticker that matches the emissivity of the surface.

Most non-metallic surfaces, although they may have different colours (VIS spectral range visible radiation for the human eye), are perfectly "black" in the FIR Far Infra-red; in other words, perfect absorbers ($r = 0$) / emitters ($\epsilon = 1$). Metal surfaces are reflectors (also having a low emission) in VIS as well as FIR. Partial absorption in the FIR may be found in corroded or non-polished metal.

In this example we show that if you wish to measure radiation losses of a polished metal surface, you get a representative measurement using a GLD sticker.

In figure 4.1.1, two sensors, one with a BLK sticker and one with a GLD sticker are mounted on the surface of an espresso machine.

The surface temperature of the polished stainless-steel surface is approximately 45 °C.

The GLD sticker on the right has an emissivity like that of the espresso machine's polished metal surface. This can be seen using an infra-red camera; both the GLD sensor and the metal surface appear bluish on the thermal image, having an apparent temperature of 35 °C. The camera actually makes an error in its temperature measurement because both surfaces do not emit radiation, while the camera assumes an emission of 1 for all surfaces. The actual temperature can be estimated from the image taken of the BLK sensor, which has a near perfect emission ϵ_{BLK} of 1 and which appears to be 45 °C. Both mounted on the same metal plate, so we may assume that the GLD sensor has the same temperature.

The camera shows that the emissivity of the GLD sticker matches the emissivity of the stainless-steel surface reasonably well. A heat flux sensor with a GLD sticker will therefore give a better approximation of the heat flux from the espresso machine's metal surface than a sensor with a black sticker.

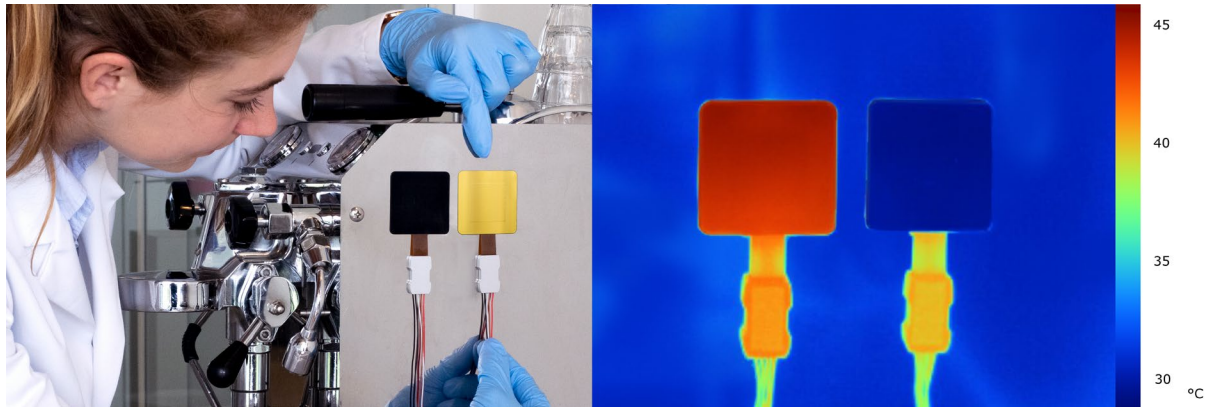

Figure 4.1.1 *Measuring with BLK – GLD stickers; application of a BLK black sticker and a GLD gold sticker on FHF models for measuring radiative and convective heat flux on an espresso machine. The machine has a polished metal surface of about 45 °C. The IR image on the right shows that the black sticker on the left, as well as the sensor wires and connector blocks, emit radiation. They appear in red on the image. The gold sticker and the metal surface have lower emission and appear as “bluish” on the image. Mounted on the same surface, the BLK and GLD stickers have the same temperature. The measurement with the sensor with the GLD sticker is most representative of the heat flux at the polished metal surface, while the sensor with the BLK sticker overestimates the heat flux.*

Users could also choose to attribute a theoretical emission to the stainless steel and estimate the radiation loss using the formula of 3.3:

$$\Phi_{\text{radiative BLK}} = \Phi_{\text{BLK}} - \Phi_{\text{convective}} = (U_{\text{BLK}}/S_{\text{BLK}}) - (U_{\text{GLD}}/S_{\text{GLD}}) \quad (4.1.1)$$

and

$$\Phi_{\text{radiative, stainless steel}} = (\epsilon_{\text{stainless steel}} / \epsilon_{\text{BLK}}) \Phi_{\text{radiative BLK}} \quad (4.1.2)$$

4.2 Sources covering part of the sensor field of view; the view factor

In case a radiating source does not occupy the full field of view, solid angle of 2π steradian, of a flat heat flux sensor, it is possible to express the irradiance received by the sensor in terms of an optical view factor, f

To calculate the radiative heat flux Φ_{incoming}

- emitted by the source,
- incoming at the heat flux sensor location
- in the heat flux sensor plane

$$\Phi_{\text{incoming}} = \sigma \cdot f \cdot \epsilon_{\text{source}} \cdot (T_{\text{source}} + 273)^4 \quad (4.2.1)$$

For example, assuming that the sensors can be represented as a point under the source, for the round infra-red radiator in figure 4.2.1 below, the view factor, f , is determined with

$$f = \sin(\theta)^2 \quad (4.2.2)$$

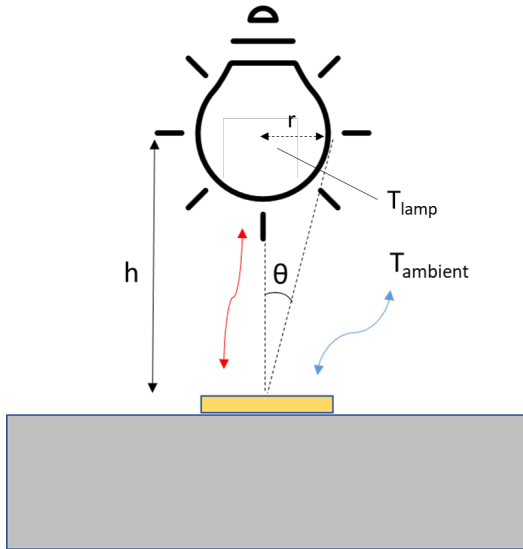

Figure 4.2.1 measuring radiative heat flux of a round source. The sensor is situated on a heat sink at T_{sensor} . The source does not fully occupy the full field of view of the sensors. Radiation from the source originates from an angle θ .

Assuming that all emission coefficients are 1, the total incoming heat flux of the radiation from the source and ambient origin at the sensors is

$$\Phi_{incoming} = \sigma \cdot f \cdot (T_{source} + 273)^4 + \sigma \cdot (1 - f) \cdot (T_{ambient} + 273)^4 \quad (4.2.3)$$

The radiative flux measured by a BLK sensor is:

$$\Phi_{radiative} = \Phi_{BLK} - \Phi_{convective\ GLD} = (U_{BLK}/S_{BLK}) - (U_{GLD}/S_{GLD}) \quad (4.2.4)$$

$$\Phi_{radiative} \text{ [SOURCE ON]} = f \cdot \alpha_{BLK, T_{source}} \cdot \Phi_{radiative, source} + (1-f) \cdot \alpha_{BLK, T_{ambient}} \cdot \Phi_{radiative, ambient} - \sigma \cdot \epsilon_{BLK, emitted} \cdot (T_{BLK} + 273)^4 \quad (4.2.5)$$

The heat flux of the source can only be measured by switching the source off, and assume the source then also returns to ambient temperature:

$$\Phi_{radiative} \text{ [SOURCE OFF]} = \alpha_{BLK, T_{ambient}} \cdot \Phi_{radiative, ambient} - \sigma \cdot \epsilon_{BLK, emitted} \cdot (T_{BLK} + 273)^4 \quad (4.2.6)$$

$\Phi_{\text{radiative, incoming, source}} =$

$$\frac{(\Phi_{\text{radiative [SOURCE ON]}} - \Phi_{\text{radiative [SOURCE OFF]}}) + f \cdot \alpha_{\text{BLK, Tambient}} \cdot \Phi_{\text{radiative, ambient}}}{\alpha_{\text{BLK, Tsource}}} \quad (4.2.7)$$

In case f is sufficiently small, indicating that only a small portion of the ambient space is shaded by the source, or in case the radiative flux from ambient sources to the sensor is small because T_{BLK} is close to T_{ambient} , the term $f \cdot \epsilon_{\text{BLK, Tambient}} \cdot \Phi_{\text{radiative, ambient}}$ may be ignored. Then

$\Phi_{\text{radiative, incoming, source}} =$

$$(\Phi_{\text{radiative [SOURCE ON]}} - \Phi_{\text{radiative [SOURCE OFF]}}) / \alpha_{\text{BLK, Tsource}} \quad (4.2.8)$$

4.3 Heat flux measurement to characterise ovens, thermal profiling

4.3.1 General principles

Heat flux sensors are frequently applied to characterise ovens, for example in the baking industry or in ovens used for production and curing of rubber insulation foams. In such applications a BLK and a GLD sensor and a thermally insulated datalogger are placed on the conveyor belt in the oven. They move through the oven at a speed representative of the normal production process, sometimes along with the product.

This process of characterisation is called Thermal Profiling, TP.

The purposes of TP may be:

- characterisation of the heat transfer in the oven
- quantifying and separating the effects of heating by air and heating by radiation
- establishing a fingerprint or reference thermal profile, not aiming at accurate heat transfer measurement. This fingerprint can later be used as a baseline. This is useful when servicing ovens, when trying to copy oven settings from one oven to another, for fault-finding, and to compare to similar processes elsewhere.

The parameters typically measured are:

- air temperature, [T_{air}]
- sensor body temperature [T_{sen}]
- total heat flux (BLK sensor) [Φ_{total}]
- convective heat flux (GLD sensor) [$\Phi_{\text{convective}}$]

Derived parameters are:

- air temperature

- local air speed, expressed as the heat transfer coefficient [C_{tr}] (characterising heating by air)
- local equivalent blackbody temperature, or incoming radiative heat flux (characterising heating by radiation) [$T_{blackbody}$]

In some cases, it is sufficient for comparative purposes only, to establish a fingerprint using only a single BLK sensor. In that case the purpose is:

- establish a total heat flux profile (radiative + convective) with a “reference sensor”.

To produce reproducible results, it is beneficial if:

- the reference sensor has a standardised geometry and heat capacity
- measurement is started at a standardised sensor body temperature

Points of attention in the TP measurement are:

- be careful with ambient air temperature measurements; temperature sensors may heat up by radiation. In that case they no longer measure the true ambient air temperature. We recommend shielding the ambient air temperatures from radiation, or using gold plated ambient air temperature sensors
- be careful to avoid condensation of fluids (water vapour) on the heat flux sensor. Heat the sensor to above any local dew point (in the oven) before starting the measurement. Condensation may be recognised by sudden increase of heat flux in high-humidity area, followed by decreasing flux when the fluid evaporates again.
- the sensor response time must match that of the process. In case transport belts move too fast relative to the radiative and convective sources, the sensor may not be able to register details of the process. On the other hand, this may not matter; the heat flux integrated over time in [J/m^2] will still be representative.
- a heat flux sensor behaves as a simple first order system; it can be described using a single time constant. The response time of such sensors may mathematically be improved by a factor 2 (made shorter), in data post-processing.
- synchronisation of BLK and GLD sensors may be an issue. Make sure they are exposed to the same source at the same time or introduce a time lag in post-processing.
- sensors must not overheat. The maximum temperature of the sensor top surface is a function of the temperature of the heat sink, to which the bottom of the sensor is connected, plus a temperature difference between bottom and top surface of the sensor generated by the local heat flux. Typical measures to limit overheating are starting the experiment with a low heat sink temperature, using a heat sink with a high heat capacity, thermally insulating the heat sink, or using a heat sink that reflects radiation. For FHF sensors the maximum rated operating temperature for continuous use is 120 °C. TP experiments are typically short-term (< 30 min) only and we may use 150 °C as maximum rated temperature.
- product may also gain heat from the conveyor belt; in some cases, “belt temperature” is measured as well
- users may try to estimate which part of heat transported to the product is radiative and which part is convective. Please note that this estimate is qualitative only

because both the convective and the radiative heat flux level and the ratio between these two depends on the product surface temperature. The heat flux sensor surface temperature may not be representative.

4.3.2 Equations typically applied in TP experiments with FHF05 series

To determine the main measured quantities T_{air} , $\Phi_{incoming}$, C_{tr} and the equivalent blackbody temperature $T_{source, blackbody}$.

Temperature corrected heat fluxes measured by BLK and GLD sensors:

$$\Phi_{GLD} = U_{GLD}/(S_{GLD} \cdot (1 + 0.002 \cdot (T_{GLD} - 20))) \quad (4.3.2.1)$$

$$\Phi_{BLK} = U_{BLK}/(S_{BLK} \cdot (1 + 0.002 \cdot (T_{BLK} - 20))) \quad (4.3.2.2)$$

Surface temperatures of BLK and GLD sensors are measured temperatures corrected for heat flux and the thermal resistance of the sensors. Usually, but not always, the measured temperatures T_{BLK} and T_{GLD} are identical, as they are mounted on the same metal heat sink.

In case we use FHF series sensors:

$$T_{BLK, corrected} = T_{BLK} + 12 \times 10^{-4} \cdot \Phi_{BLK} \quad (4.3.2.3)$$

$$T_{GLD, corrected} = T_{GLD} + 5.5 \times 10^{-4} \cdot \Phi_{GLD} \quad (4.3.2.4)$$

The heat transfer coefficient:

$$C_{tr} = \Phi_{GLD}/(T_{air} - T_{GLD, corrected}) \quad (4.3.2.5)$$

The radiative part $\Phi_{radiative}$ of the total flux Φ_{BLK}

$$\begin{aligned} \Phi_{radiative} &= \Phi_{BLK} - \Phi_{convective} \\ &= U_{BLK}/(S_{BLK} \cdot (1 + 0.002 \cdot (T_{BLK} - 20))) - C_{tr} \cdot (T_{air} - T_{BLK, corrected}) \end{aligned} \quad (4.3.2.6)$$

In case the sensor remains at relatively low temperature and the source is an infra-red lamp,

$$-40 \text{ } ^\circ\text{C} < T_{BLK} < 70 \text{ } ^\circ\text{C}, \quad (4.3.2.7)$$

$$300 \text{ } ^\circ\text{C} < T_{source} < 600 \text{ } ^\circ\text{C} \quad (4.3.2.8)$$

We then assume:

$$\varepsilon_{BLK, emitted} = 0.89 \quad (4.3.2.9)$$

$$\alpha_{BLK, incoming} = 0.95 \quad (4.3.2.10)$$

The incoming radiative flux:

$$\Phi_{\text{incoming}} = 1.05 \cdot \Phi_{\text{radiative}} + 0.94 \cdot \sigma \cdot (T_{\text{BLK}} + 273)^4 \quad (4.3.2.11)$$

$\Phi_{\text{convective, incoming}}$ may also be calculated, but that parameter is of less use than the C_{tr} , because it is valid only for an object with a certain surface temperature T_{surface}

$$\Phi_{\text{convective}} = C_{\text{tr}} \cdot (T_{\text{air}} - T_{\text{surface}}) \quad (4.3.2.12)$$

Another way to express the incoming radiative flux is the equivalent blackbody temperature of the radiation source, assuming an emissivity of $\varepsilon = 1$ of the source:

$$T_{\text{source, blackbody}} = \left((\Phi_{\text{radiative}} + 0.89 \cdot \sigma \cdot (T_{\text{BLK, corrected}} + 273)^4) / (0.95 \cdot \sigma) \right)^{1/4} - 273 \quad (4.3.2.13)$$

4.3.3 Warnings in case of sensor overheating

To warn for overheating we monitor the highest temperature, which is the surface temperature of the BLK sensor. In case of sensors of the FHF series:

$$T_{\text{BLK, corrected}} = T_{\text{BLK}} + 12 \times 10^{-4} \cdot \Phi_{\text{BLK}} \quad (4.3.3.1)$$

$$T_{\text{BLK, corrected}} < 120 \text{ } ^\circ\text{C} \quad (4.3.3.2)$$

5 Specifications of BLK – GLD sticker series

5.1 Specifications of BLK – GLD stickers

BLK – GLD sticker series can be applied to a heat flux sensor. BLK stickers provide the sensor with a black absorbing surface so that it measures convective and radiative heat flux, in W/m². GLD stickers provide the sensor with a gold reflecting surface so that it measures convective heat flux only. Combining BLK and GLD stickers, applied to two separate heat flux sensors, allows for measurement of radiative heat flux.

Table 5.1.1 *Specifications of BLK – GLD sticker series (continued next page)*

BLK SPECIFICATIONS	
Product type	sticker
Measurand	convective + radiative heat flux
Measurand in SI units	heat flux density in W/m ²
Measurement range	(-2 to 2) × 10 ³ W/m ² (HFP01) (-10 to 10) × 10 ³ W/m ² (FHF05 series)
Measurement function / required programming	$\Phi_{\text{convective+radiative}} = U/S$
Rated temperature range - continuous use	-40 to +150 °C
Rated temperature range - short intervals	-40 to +260 °C
Spectral range (UV-VIS-NIR-FIR)	250 to > 10000 × 10 ⁻⁹ m
Absorption over range	> 95 % see appendix for more information
Carrier material	Polyimide (Kapton®)
Coating material	fully inorganic metal-based
Adhesive	3M™ VHB™ F9460PC acrylic transfer tape
Sticker thickness	0.14 × 10 ⁻³ m
Sticker thermal resistance	10 × 10 ⁻⁴ K/(W/m ²)
Sticker thermal conductivity	1.38 × 10 ⁻¹ W/(m·K)
GLD SPECIFICATIONS	
Product type	sticker
Measurand	convective heat flux
Measurand in SI units	heat flux density in W/m ²
Measurement range	(-2 to 2) × 10 ³ W/m ² (HFP01) (-10 to 10) × 10 ³ W/m ² (FHF05 series)
Measurement function / required programming	$\Phi_{\text{convective}} = U/S$
Rated temperature range – continuous use	-185 to +150 °C
Rated temperature range – short intervals	-185 to +260 °C
Spectral range (NIR-FIR)	700 to > 10000 × 10 ⁻⁹ m
Reflection over range	> 95 % see appendix for more information
Spectral range (VIS)	400 to 700 × 10 ⁻⁹ m
Reflection over range	> 80 % see appendix for more information
Solar absorption	< 20 %
Carrier material	Polyimide (Kapton®)
Coating material	gold

Table 5.1.1 Specifications of BLK – GLD sticker series (started on previous page, continued next page)

Adhesive	ARcare® 8026 silicone transfer tape
Sticker thickness	0.05×10^{-3} m
Sticker thermal resistance	3.5×10^{-4} K/(W/m ²)
Sticker thermal conductivity	1.45×10^{-1} W/(m·K)
GENERAL SPECIFICATIONS	
Effect on sensor sensitivity	negligible
Effect on type T sensor (FHF sensors only)	negligible
Additional response time (95 %)	3 s (nominal)
Rated temperature range when applied to sensor	see sensor specifications
Sticker dimensions	
BLK-10X10 / GLD-10X10	$(10 \times 10) \times 10^{-3}$ m
BLK-15X30 / GLD-15X30	$(15 \times 30) \times 10^{-3}$ m
BLK-50X50 / GLD-50X50	$(50 \times 50) \times 10^{-3}$ m
BLK-15X85 / GLD-15X85	$(15 \times 85) \times 10^{-3}$ m
BLK-85X85 / GLD-85X85	$(85 \times 85) \times 10^{-3}$ m
BLK-80 / GLD-80	$\varnothing 80 \times 10^{-3}$ m
Bending radius	see sensor specifications for limiting bending radius
Protection foil	remove before measurement
INSTALLATION AND USE	
Typical conditions of use	in experiments, in measurements in laboratory and industrial environments. Exposed to heat fluxes for periods of several minutes to several years. Sensor connected to user-supplied data acquisition equipment. Regular inspection of the sensor and sticker surface. Continuous monitoring of sensor temperature. No special requirements for immunity, emission, chemical resistance.
Recommended maintenance	see recommendations in this user manual Sticker surfaces should be kept clean General cleaning: do not use any solvents, gently wipe with optical microfibre cloth and if needed demineralised water.
Application of stickers on sensor	FHF: apply on side without dot HFP: apply on side coloured red sensors are applied so that incoming heat flux on that side produces a positive heat flux signal. see recommendations in this user manual see instruction sheet included with delivery see our instruction video on YouTube, or order sensors with stickers pre-applied at the factory
Installation of sensors	Preferably install sensors with BLK and GLD on the same heat sink see recommendations in the sensor manuals see recommendations in this user manual
MEASUREMENT ACCURACY	
Uncertainty of the sensor	Users should make their own uncertainty evaluation see user manual of the sensor for more information about calibration method and uncertainties
Uncertainty of the measurement	Users should make their own uncertainty evaluation statements about the overall measurement uncertainty can only be made on an individual basis

Table 5.1.1 Specifications of BLK – GLD sticker series (started on previous pages)

VERSIONS AND ORDER CODES	
BLK-10X10 / GLD-10X10	to be used with model FHF05-10X10
BLK-15X30 / GLD-15X30	to be used with model FHF05-15X30
BLK-50X50 / GLD-50X50	to be used with model FHF05-50X50
BLK-15X85 / GLD-15X85	to be used with model FHF05-15X85
BLK-85X85 / GLD-85X85	to be used with model FHF05-85X85
BLK-80 / GLD-80	to be used with HFP01 heat flux sensor
OPTIONS	
Pre-applied to the sensor	When opting for pre-application of the sticker to the sensor at the factory, please use the following ordering code: product code sensor with wire / cable length indicated + product code sticker example: HFP01-05-GLD-80 for an HFP01 with 5 metres of cable and a pre-applied gold sticker

5.2 Dimensions of BLK – GLD stickers

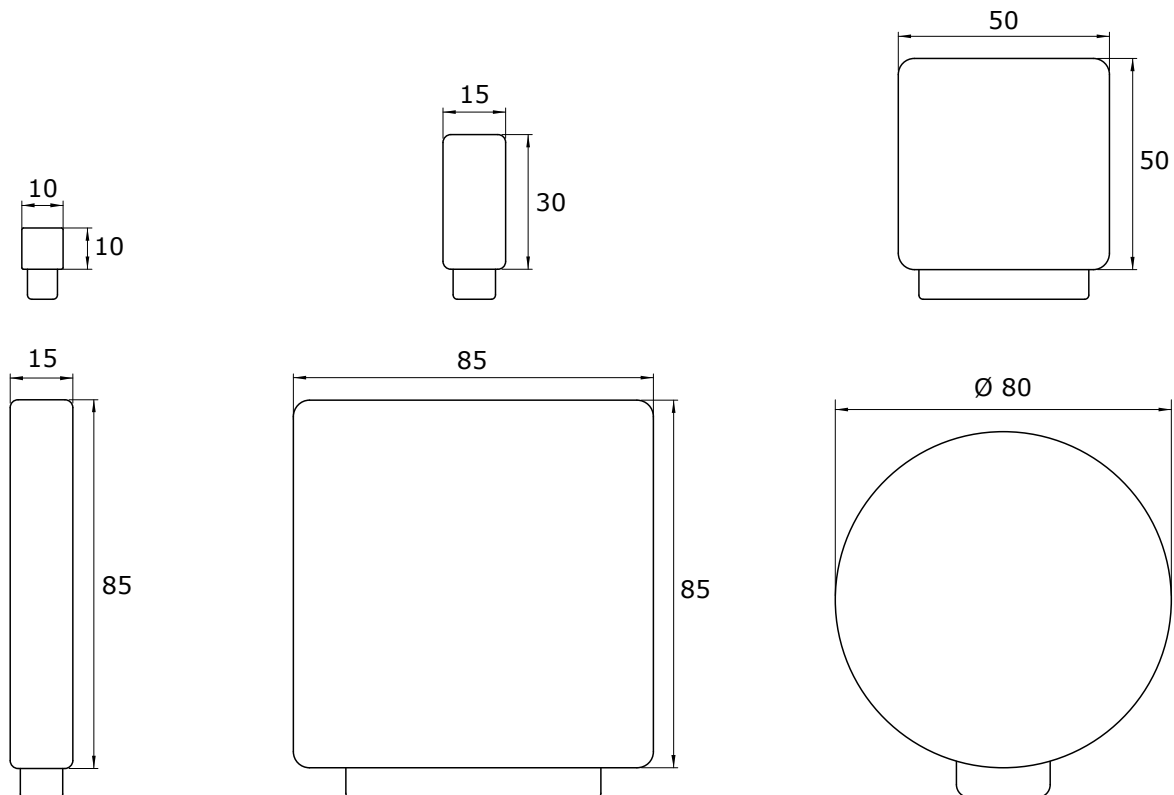

BLK sticker thickness = 0.14 mm

GLD sticker thickness = 0.05 mm

Figure 5.2.1 Dimensions of BLK – GLD sticker series; all dimensions in $\times 10^{-3}$ m for both BLK and GLD sticker. Top row from left to right: -10X10, -15X30, -50X50. Bottom row from left to right: -15X85, -85X85 and -80. All BLK stickers have a thickness of 0.14 mm, GLD stickers have a thickness of 0.05 mm.

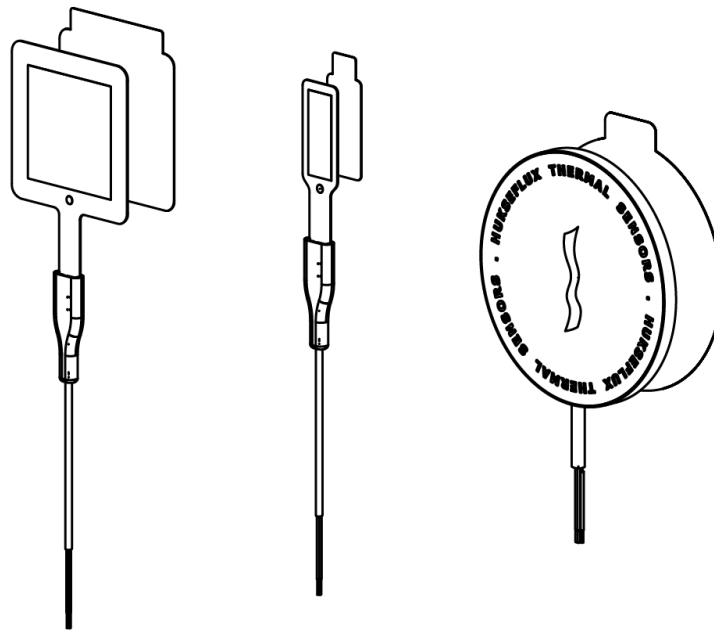

Figure 5.2.2 The dimensions of the BLK - GLD stickers match the dimensions of the corresponding heat flux sensors FHF05 series and HFP01

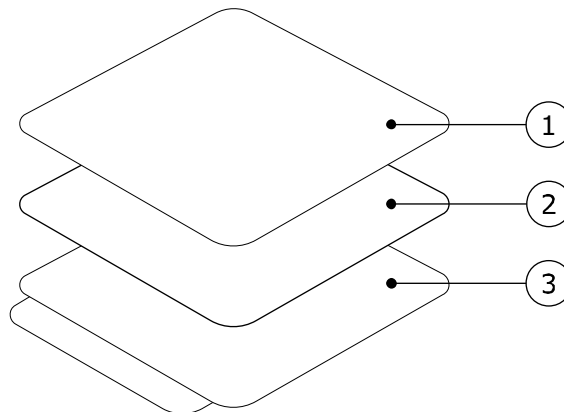

Figure 5.2.3 Layer build-up for the BLK - GLD sticker series. Depicted is BLK/GLD-50X50

- (1) protective foil
- (2) BLK / GLD sticker
- (3) release liner with peeling tab

6 Installation of BLK – GLD sticker series

6.1 Application procedure

For the best possible measurement of heat flux sensors with BLK - GLD stickers applied, it is important that the application is done correctly. The stickers must be aligned with the sensor, without leaving scratches, (finger) grease, or inclusion of air pockets.

It is advised to do a quick instrument check of the sensor, before applying the sticker. See the user manual of the sensor for further instructions.

NOTICE

Wear powderless gloves during application.

NOTICE

BLK – GLD stickers are designed for one-time application. Removing stickers after application will make them permanently unsuitable for use.

NOTICE

Do a quick functional check of sensor performance before application of the sticker.

- When applying a BLK black or GLD gold sticker to FHF05(SC), please note it should be applied to the side of the heat flux sensor where the dot on the foil is NOT visible.
- When applying a BLK black or GLD gold sticker to HFP01, please note it should be applied to the side of the heat flux sensor which is coloured red.

Table 6.1.1 Application procedure for BLK – GLD stickers (continued next page)

- 1 Place the sensor on a stable surface as shown on the right. Make sure the correct side is facing upward. Before applying the sticker, clean the sensor surface using alcohol (IPA) wipe provided with the sticker.

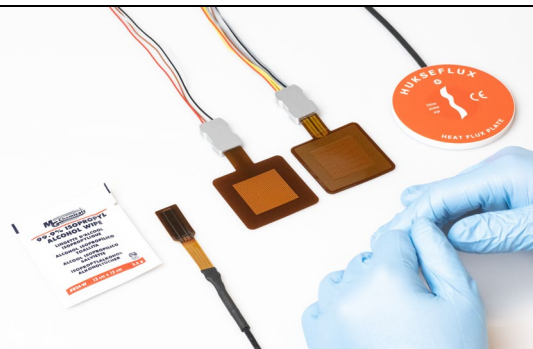

- 2 Partially peel and cut the release liner (approximately 1 cm). Do not remove the release liner completely.

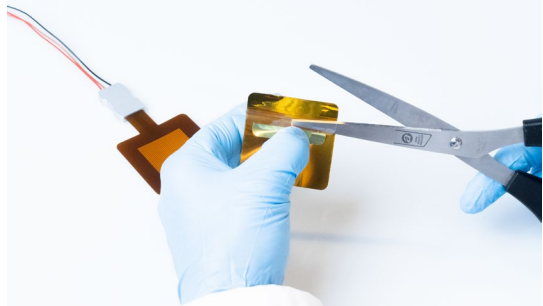

- 3 Position the sticker onto the sensor surface without applying force to the top part of the sticker. If the sticker does not align properly, carefully remove the sticker and try again.

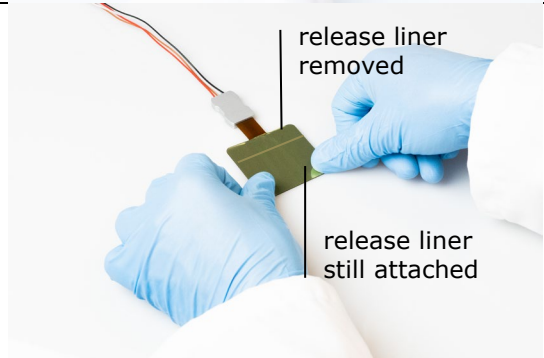

- 4 Once the sensor and sticker are well aligned, fixate the top part of the sticker. Make sure no air bubbles are enclosed. Do not remove the sticker after fixating it as it might damage the coating of the sticker.

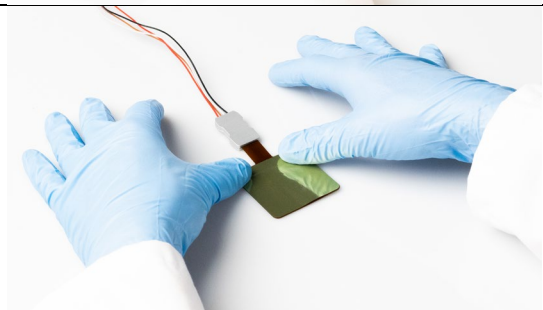

- 5 Slowly peel off the remaining release liner while simultaneously applying the rest of the sticker. Again, avoid including air pockets.

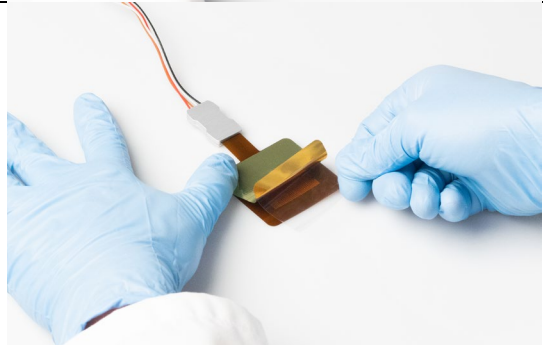

- 6 Remove the protective foil before measuring. Handle with care once the protective foil is removed.

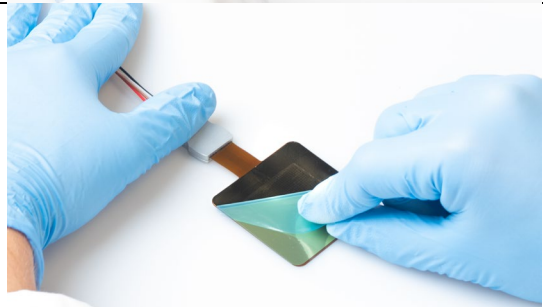

6.2 Site selection and sensor installation

Table 6.2.1 Recommendations for installation of sensors with BLK – GLD stickers

Location	choose a location that is representative of the process that is analysed avoid direct exposure to the sun
Positioning	when using multiple sensors with BLK and GLD stickers, place them side by side on the same heat sink (a metal plate) so that they have approximately the same temperature
Surface cleaning and levelling	create a clean and smooth surface before mounting the sensor
Mounting: orientation	when mounting a sensor with a BLK or GLD sticker, keep the directional sensitivity in mind orient the sensor surface with sticker away from the object on which it is mounted
Mounting: avoiding strain on sensor cable or wires	during installation as well as operation, the user should provide proper strain relief of the sensor cable/wires so that they are not exposed to significant force first install the cable/wires including strain relief and after that install the sensor
Mounting: curved surfaces	when mounting sensors on curved surfaces, apply BLK – GLD stickers before mounting the sensor. See the user manual of the sensor for its rated bending radius
Short term installation	avoid any air gaps between sensor and surface. Air thermal conductivity is in the 0.02 W/(m·K) range, while a common glue has a thermal conductivity around 0.2 W/(m·K). An air gap of 0.1×10^{-3} m increases the effective thermal resistance of the sensor by 200 % to avoid air gaps, we recommend thermal paste or glycerol for short term installation. When mounting on curved surfaces, glycerol is not recommended as it will leak out use tape to attach the sensor on the surface. Tape only over the passive guard area (the area without thermopile traces) Provide strain relief to the sensor wires usually, the cables are provided with an additional strain relief, for example using a cable tie mount as in Figure 6.2.1
Permanent installation	for long-term installation, fill up the space between sensor and object with silicone construction sealant, silicone glue or silicone adhesive that can be bought in construction depots the use of thermal paste for permanent installation is discouraged because it will dry out over time. Silicone glue is more stable and reliable
Electrical connection	when measuring incoming radiation, connect the sensor as indicated in the user manual of the sensor. Incoming radiation will then give a positive sensor signal for measurements of outgoing radiation, switch the [+] and [-] wires of the sensor to change its polarity. Outgoing radiation will then give a positive sensor signal

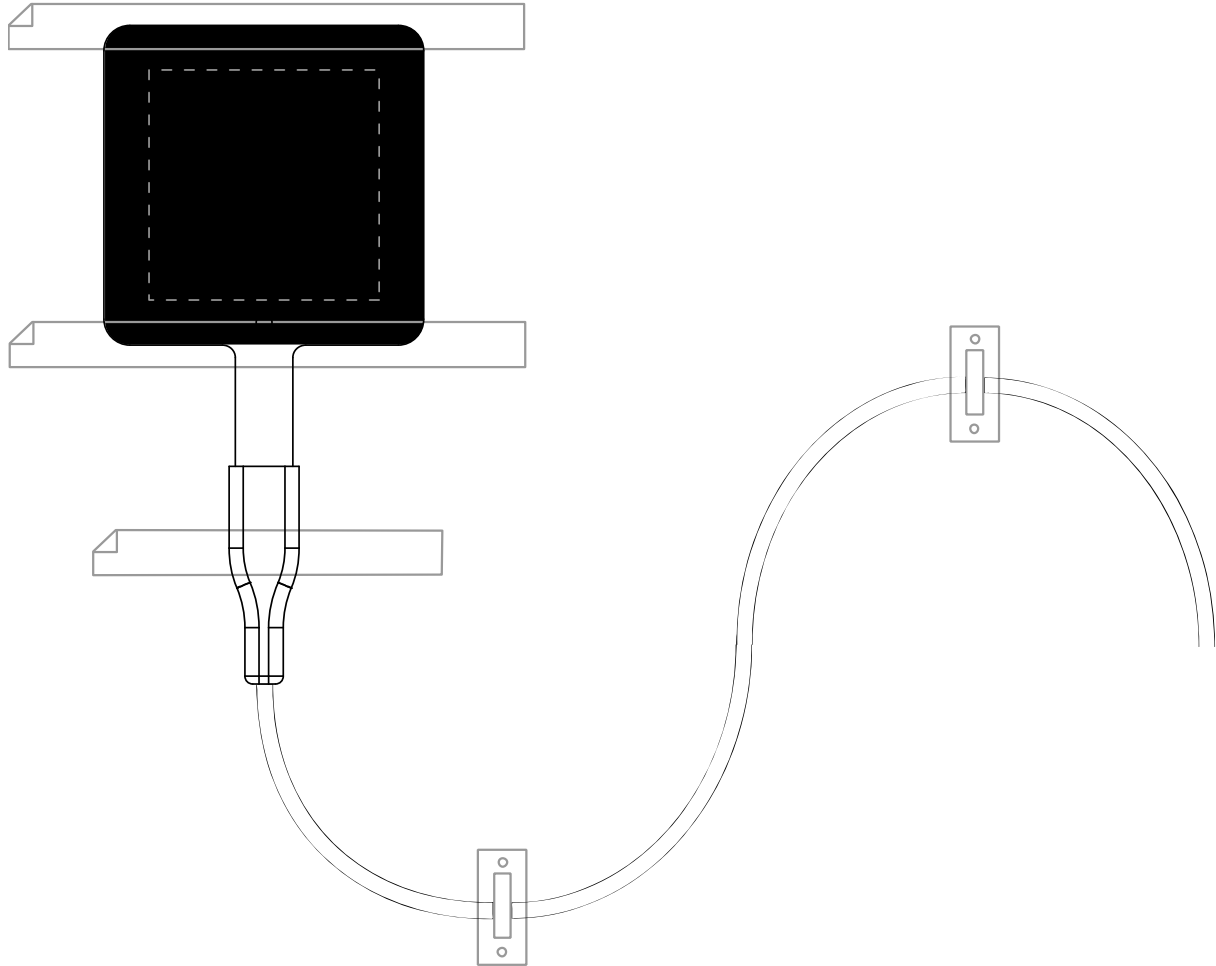

Figure 6.2.1 *Installation of model FHF05-50X50 with BLK sticker using tape to attach the sensor and FHF05-50X50 connection block serving as strain relief. Extra strain relief on the wires is provided using cable tie mounts equipped with double-sided adhesive tape. As also indicated in the sensor manual, tapes for mounting of the sensor should only cover the passive guard area and not over the sensing area (the latter indicated by a dashed line).*

7 Maintenance and trouble shooting

7.1 Recommended maintenance and quality assurance

Hukseflux heat flux sensors with sticker perform reliably when kept clean. Unreliable sensor output can be detected by scientific judgement, for example by looking for unreasonably large or small measured values. The preferred way to ensure a reliable sensor output, is a regular critical inspection of surfaces and review of the measured data.

Table 7.1.1 *Recommended maintenance of BLK – GLD stickers.*

MINIMUM RECOMMENDED STICKER MAINTENANCE			
	INTERVAL	SUBJECT	ACTION
1	as required for the application	cleaning	<p>Clean the stickers so that they keep their required reflective and absorptive properties. Especially the GLD stickers must be treated with care, the gold layer thickness is very limited, and it may easily be rubbed away by friction.</p> <p>General cleaning: do not use any solvents, gently wipe with optical microfibre cloth and if needed demineralised water.</p> <p>GLD stickers only: in case normal cleaning does not work use alcohol or acetone on a soft cloth.</p> <p>BLK stickers: do not use any solvents.</p> <p>In case of damage, users may remove stickers and replace them by a new sticker.</p> <p>Sensors may also be sent to Hukseflux to apply a new sticker.</p>

For sensor maintenance: consult the sensor manual. Here are some general recommendations.

Table 7.1.2 *General recommended maintenance of heat flux sensors. If possible, the data analysis is done on a daily basis*

GENERAL: MINIMUM RECOMMENDED HEAT FLUX SENSOR MAINTENANCE			
	INTERVAL	SUBJECT	ACTION
1	1 week	data analysis	compare measured data to the maximum possible or maximum expected heater power, to other measurements from other redundant instruments and to data previously measured under identical circumstances. Look for any patterns and events that deviate from what is normal or expected. Compare to acceptance intervals.
2	6 months	inspection	inspect wire quality, inspect mounting, inspect location of installation, look for seasonal patterns in measurement data
3	2 years	recalibration	recalibration by comparison to a calibration standard instrument in the field, see following paragraphs. recalibration by the sensor manufacturer
4	2 years	lifetime assessment	judge if the instrument will be reliable for another 2 years, or if it should be replaced

7.2 Trouble shooting

Table 7.2.1 *Trouble shooting for heat flux sensors with BLK – GLD stickers*

General	Inspect the quality of application / installation. Inspect the sticker surface for any damage or stains like grease or dirt. Inspect if there are any air pockets between the sticker, sensor and surface. Check if the sensor wires are properly attached to the data logger. Check the condition of the wires.
Grease or dirt on BLK surface	Gently clean with a soft cloth, like an anti-static or microfiber cloth, and demineralised water. Avoid IPA or acetone as it will remove the black coating. Wear powderless gloves during cleaning.
Grease or dirt on GLD surface	Gently clean with a soft cloth, like an anti-static or microfiber cloth, and IPA or acetone. Avoid touching the sticker surface with anything other than a soft cloth as it highly prone to scratching. Wear powderless gloves during cleaning.
The sensor signal has the wrong polarity	Check if the sticker is applied to the correct side of the sensor. See the application steps in table 4.1.1 or the installation movie on our YouTube channel for more information. Polarity issues may also be solved in post-processing of data.
Issues with sensor signal	See sensor manuals for help on trouble shooting with the sensor signal. A good start is to measure the electrical resistance of the sensor. Close to 1 Ohm indicates a short-circuit, more than 1 MΩ indicates a wire or sensor failure.

7.3 Calibration and on-site checks

The recommended calibration interval of heat flux sensors is 2 years.

Recalibration of field heat flux sensors with stickers is ideally done by the sensor manufacturer.

On-site (field) calibration is possible by comparison to a calibration reference sensor. Usually mounted side by side, alternatively mounted on top of the field sensor.

Hukseflux main recommendations for on-site calibrations are:

- 1) to compare to a calibration reference of the same brand and type as the sensor that is used
- 2) to connect both to the same electronics, so that electronics errors (also offsets) are eliminated
- 3) to mount all sensors on the same platform, so that they have the same body temperature
- 4) typical duration of test: > 24 h
- 5) typical heat fluxes used for comparison: > 600 W/m²
- 6) to correct deviations of more than ± 20 %. Lower deviations may be interpreted as acceptable and may not necessarily lead to a revised sensitivity

Users may also design their own calibration experiment, for example using a well-characterised foil heater.

8 Appendices

8.1 Reflection versus wavelength and source temperature

Figures 8.1.1 and 8.1.2 show the reflection of the BLK and GLD stickers as a function of wavelength of the incoming radiation. Upon request, the data from these graphs are also available in CSV format.

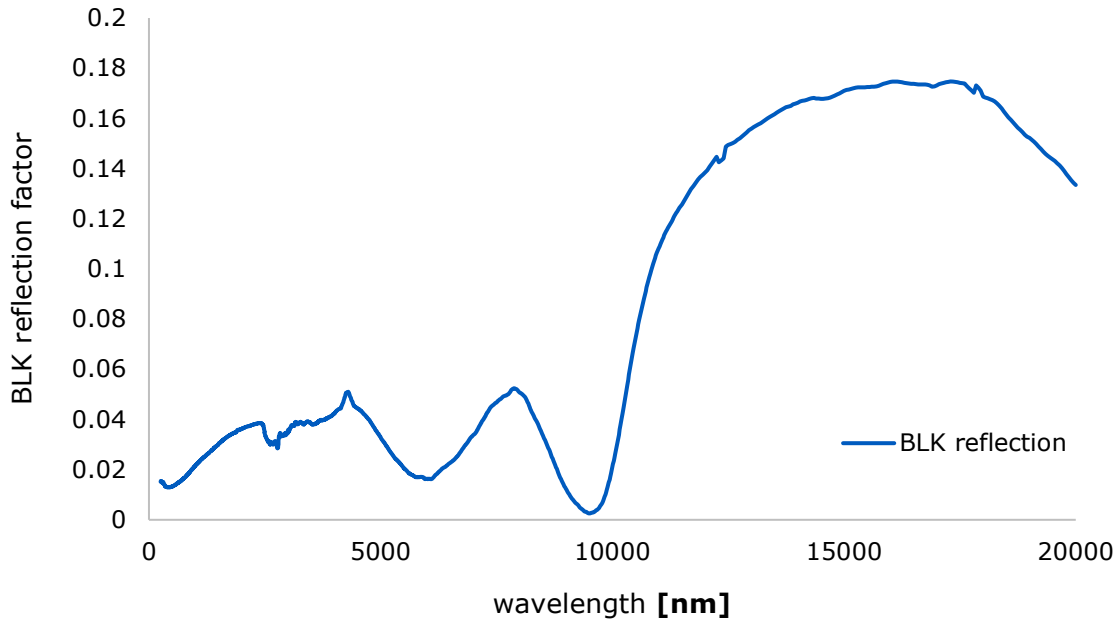

Figure 8.1.1 reflection factor of BLK sticker as a function of wavelength of the incoming radiation

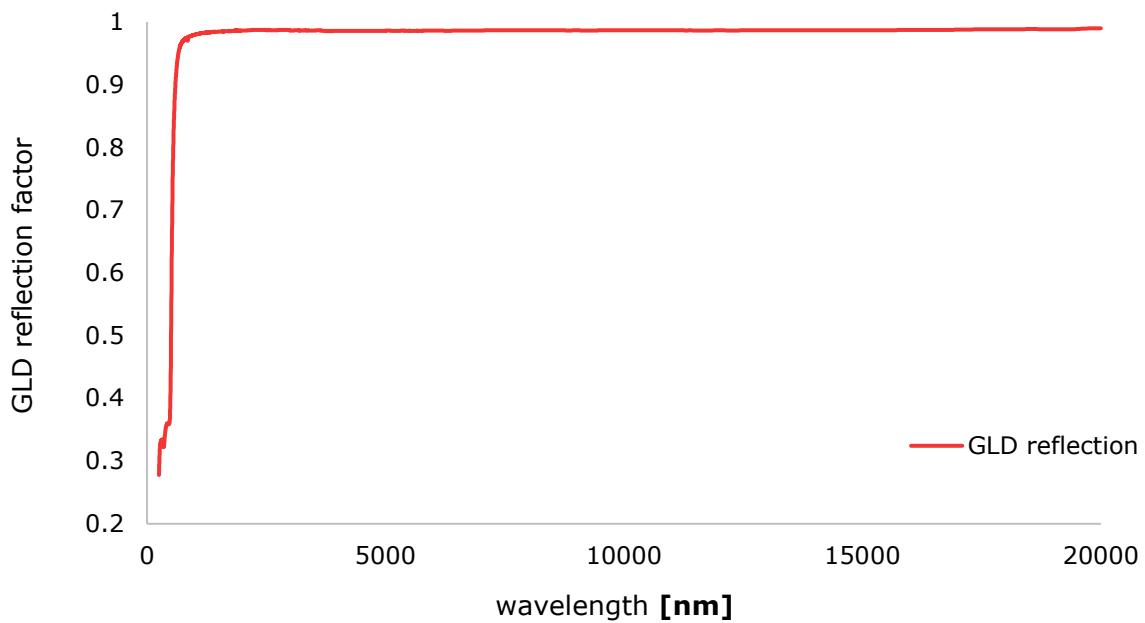

Figure 8.1.2 reflection factor of GLD sticker as a function of wavelength of the incoming radiation

Usually, the spectral composition of the source is not known exactly. If the source can be reasonably described as a blackbody source of a certain temperature T , an average reflectance factor can be calculated by integrating the reflectance of the sticker with the blackbody spectrum. This way, the formulas of section 2.3 can be used.

Figures 8.1.3 and 8.1.4 and table 8.1.1 show the average reflection factor for the BLK and GLD sticker for blackbody sources of different temperatures.

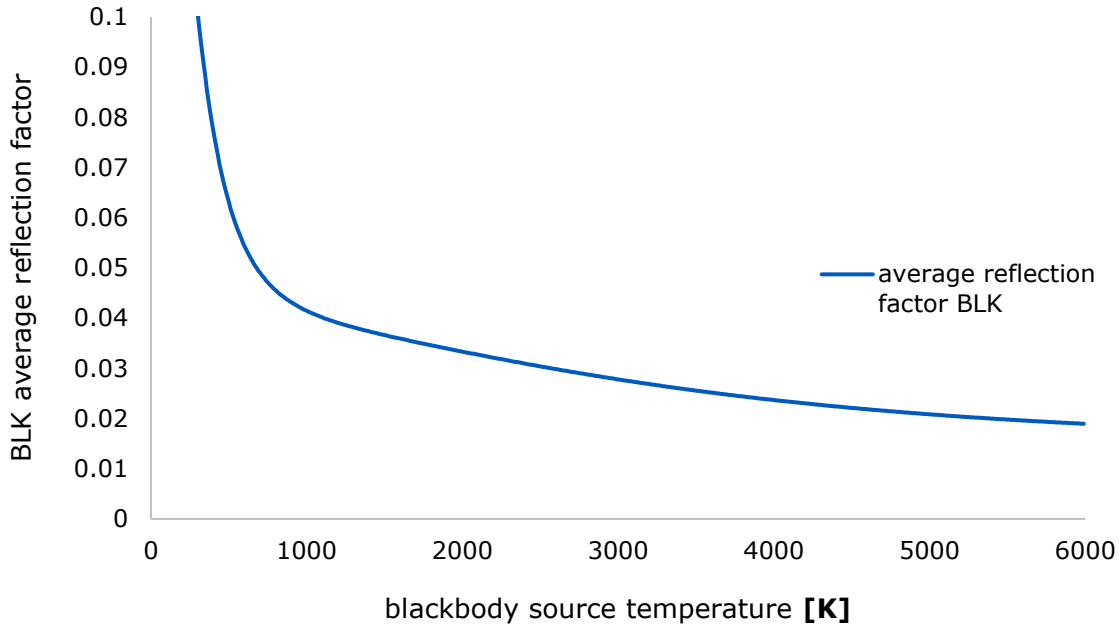

Figure 8.1.3 average reflection factor of BLK sticker when measuring radiation from blackbody sources of different temperatures

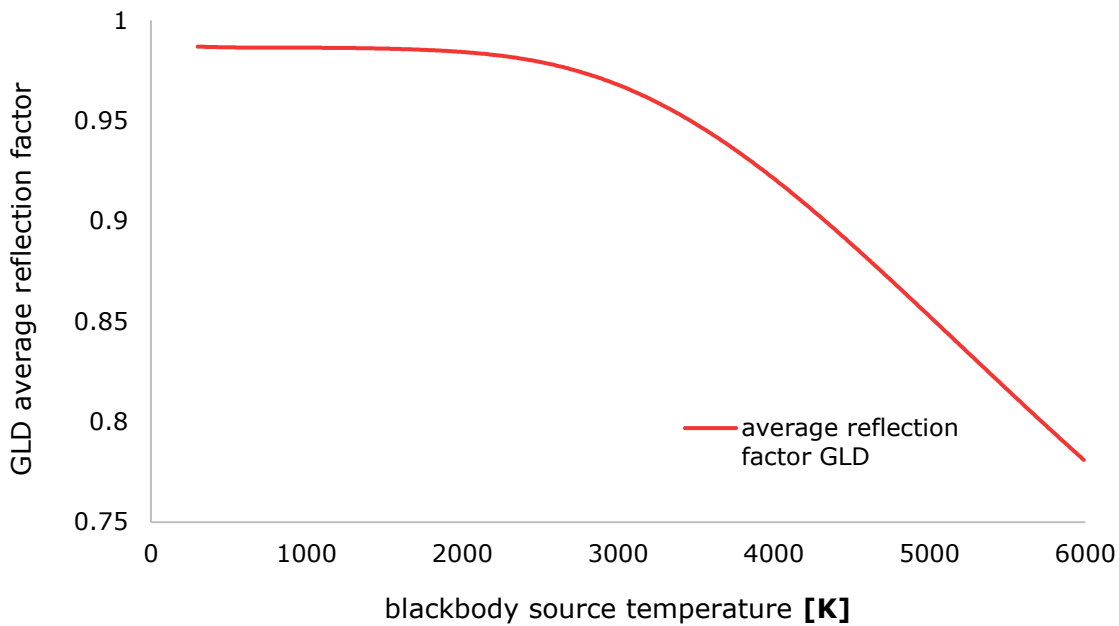

Figure 8.1.4 average reflection factor of GLD sticker when measuring radiation from blackbody sources of different temperatures

Table 8.1.1 average reflection factors of BLK and GLD for various blackbody source temperatures

blackbody source temperature [°C]	average reflection factor BLK	average reflection factor GLD
-40	0.13	0.99
-30	0.12	0.99
-20	0.12	0.99
-10	0.12	0.99
0	0.12	0.99
10	0.11	0.99
20	0.11	0.99
30	0.11	0.99
40	0.11	0.99
50	0.10	0.99
60	0.10	0.99
70	0.10	0.99
80	0.10	0.99
90	0.09	0.99
100	0.09	0.99
150	0.08	0.99
200	0.07	0.99
250	0.07	0.99
300	0.06	0.99
350	0.06	0.99
400	0.05	0.99
450	0.05	0.99
500	0.05	0.99
600	0.05	0.99
700	0.04	0.99
800	0.04	0.99
900	0.04	0.99
1000	0.04	0.99
1500	0.04	0.99
2000	0.03	0.98
2500	0.03	0.97
3000	0.03	0.96
3500	0.02	0.93
4000	0.02	0.90
4500	0.02	0.87
5000	0.02	0.83
5500	0.02	0.80

8.2 EU declaration of conformity



We, Hukseflux Thermal Sensors B.V., Delftechpark 31, Delft,
The Netherlands

hereby declare under our sole responsibility that:

Product model BLK GLD sticker series, all models*
Product type Stickers

is in conformity with the following directives:

2011/65/EU The Restriction of Hazardous Substances Directive

This conformity is declared using the relevant sections and requirements of the following standards:

Hazardous substances RoHS 2 and 215/863 amendment

A handwritten signature in blue ink, appearing to be 'Eric Hoeksema'.

Eric HOEKSEMA
Director
Delft
June 30, 2022

* NOTE: these are passive components. When implemented in a system, this system should be subjected to independent conformity assessment.

