



USER MANUAL **TPSYS20**

High-accuracy
thermal conductivity measuring system



Cautionary statements

Cautionary statements are subdivided into four categories: danger, warning, caution and notice according to the severity of the risk.

 DANGER
Failure to comply with a danger statement will lead to death or serious physical injuries.

 WARNING
Failure to comply with a warning statement may lead to risk of death or serious physical injuries.

 CAUTION
Failure to comply with a caution statement may lead to risk of minor or moderate physical injuries.

NOTICE
Failure to comply with a notice may lead to damage to equipment or may compromise reliable operation of the instrument.

Contents

Cautionary statements	2
Contents	3
List of symbols	4
Introduction	5
Accessories	9
1 Ordering and checking at delivery	10
1.1 Ordering TPSYS20	10
1.2 Included items	10
2 Instrument principle and theory	12
2.1 Operating principle of thermal needle probes	12
2.2 Measurement and Control Unit	14
2.3 Measurement model and data analysis	15
3 Specifications	18
3.1 Specifications of TPSYS20	18
3.2 Dimensions of TPSYS20	22
4 Installation and connection	23
4.1 Hardware installation	23
4.2 Opening the graphical user interface	24
4.3 Setting the system clock	25
4.4 Setting the net frequency filter	26
4.5 Overview of the graphical user interface	26
5 Making measurements	31
5.1 Setting the thermal needle probe parameters	31
5.2 Thermal needle probe calibration	32
5.3 Thermal conductivity measurements	35
5.4 Retrieving measurement data	40
6 Data analysis	43
6.1 The tool	43
6.2 Data import	45
6.3 Analysis process	46
6.4 Analysis results	49
7 Maintenance and trouble shooting	52
7.1 Recommended maintenance and quality assurance	52
7.2 Trouble shooting	53
8 Appendices	55
8.1 Theory	55
8.2 Uncertainty assessment	58
8.3 Thermal properties of some common materials	60
8.4 Calibration	62
8.5 Using the external trigger input	65
8.6 TPSYS20 field use	66
8.7 Thermal needle probe wiring	70
8.8 LoggerLink app	71
8.9 Campbell Scientific Device Configuration Utility	72
8.10 EU declaration of conformity	74

List of symbols

Quantities

	Symbol	Unit
Heater current	I	A
Heater electrical resistance per unit length	R_L	Ω/m
Heater length	L	m
Heater power	Q	W/m
Heating time	t_{heat}	s
Specimen diameter	D_{specimen}	m
Temperature	T	$^{\circ}\text{C}$
Temperature difference	ΔT	K
Time	t	s
Thermal conductivity	λ	W/(m·K)
Thermal diffusivity	α	m^2/s
Thermocouple sensitivity	S	mV/K
Expanded uncertainty in a	$U(a)$	units of a
Standard uncertainty in a	$u(a)$	units of a
(Relative) expanded uncertainty in a	$U(a)/a$	%
(Relative) standard uncertainty in a	$u(a)/a$	%
Coverage factor of $U(a)$	k	-

Acronyms

GUI	Graphical User Interface
KD	Keyboard Display
MCU	Measurement Control Unit
PC	Personal Computer
PSU	Power Supply Unit

Introduction

TPSYS20 is an accurate and user friendly system for measuring thermal conductivity. Its main components are the TP02 thermal needle probe (or its smaller equivalent, model TP08), the MCU Measurement and Control Unit and software.

This user manual describes the use of the TPSYS20 system in combination with TP02 or TP08. There are slight differences in requirements for heating time, specimen size and the use of containers for the specimen. For more details about the TP02 and TP08 thermal needle probes themselves, please consult the separate TP02 and TP08 user manuals. The general text of the TPSYS20 user manual covers laboratory experiments. Field measurements are possible as well, but are less common. These are treated in the appendix.

TP02 and TP08 are designed for measuring thermal conductivities in the range from 0.1 to 6.0 W/(m·K). The measurement principle is the transient line source technique, in which the thermal conductivity of a specimen is determined from the step response of the specimen temperature to heat from a linear heater. The MCU takes care of the measurement and control process and provides a convenient graphical user interface in the form of a webpage. TPSYS20 is particularly suitable for thermal conductivity measurements in a laboratory environment. If needed, TPSYS20 can be powered from a 12 V battery, so that it may be used in the field.

TPSYS20 is operated in conjunction with a PC. An intuitive and easy-to-use graphical user interface allows the user to set measurement parameters, control measurements, view measurement progress and view and download measurement data.



Figure 0.1 Application of the complete TPSYS20 measuring system in a laboratory environment using a CRC01 calibration reference cylinder

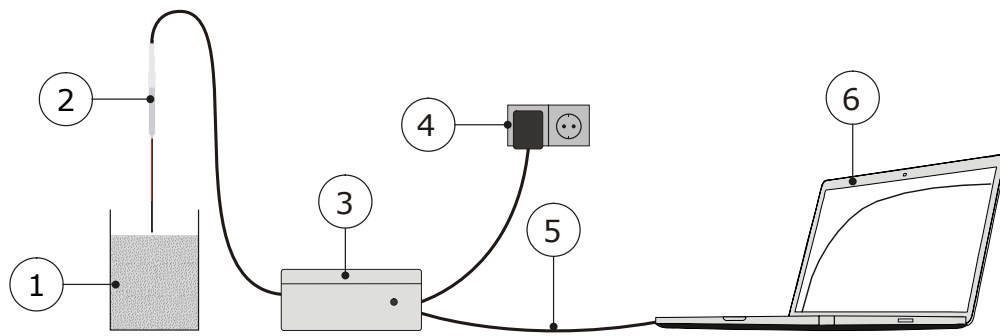

Figure 0.2 TPSYS20 standard configuration: Sample (1), Needle model TP02 or TP08 (2), MCU Measurement and Control Unit (3), Adapter suitable for both 230 and 110 VAC (4), USB or ethernet connection (5), PC (not included) (6)

TPSYS20 advantages

- **Connection via Ethernet or USB.** The MCU can be connected to a local area network (LAN) via ethernet or directly to a PC via USB.
- **Intuitive and easy-to-use graphical user interface.** The MCU acts as a server that provides a graphical user interface in the form of a webpage. The graphical user interface is accessible through a web browser. No software installation is required.
- **High-accuracy thermal conductivity measurements.** Thermal Needle Probes, also known as Non-Steady-State Probes (NSSPs) and line-source probes are designed for high-accuracy measurements. The transient-line source method is sensitive to the specimen's thermal conductivity only. It is insensitive to other specimen properties and there is no need to make assumptions about the specimen heat capacity or thermal diffusivity. This makes it an ideal method for measuring thermal conductivity.
- **Adjustable constant current source.** The current source in the MCU provides a stable heater current that can be adjusted such that a broad range of thermal conductivities can be measured.
- **Measurement and analysis of heating and cooling phase.** Users can choose to measure heating phase only or to measure heating and cooling phase. The latter reduces effect of specimen temperature drift on the measurement result.



Figure 0.3 TPSYS20 is delivered with either a TP02 Non-Steady-State Probe or its smaller equivalent TP08.

Suggested use

NSSPs are particularly suitable for measuring the thermal conductivity of fine granular materials, powders, pastes, gels and highly viscous fluids in which a needle probe can be easily inserted. Harder materials such as rocks may also be measured provided that a hole can be drilled to insert the probe. Examples of typical specimen materials include soils, thermal backfill materials, sediments, foodstuff, sludges, paints and glues. Areas of application include measurement of soils for thermal management of high-voltage electric cables, pipelines and ground heat exchangers; measurement of plastics for the optimisation of material processing; material characterisation.

TPSYS20 can be used to measure thermal conductivities in the range from 0.1 to 6.0 W/(m·K). Recommended specimen dimensions are a diameter of 100 mm or more and a length of at least 160 mm for TP02 (specimen volume ~1.3 L) or 80 mm for TP08 (specimen volume ~ 0.65 L). Use of smaller specimen may be possible depending on the thermal properties of the specimen and the required accuracy.

Standards

The measurement with TPSYS20 complies with the IEEE Guide for Soil Thermal Resistivity Measurements (IEEE 442-2017) as well as with ASTM D5334 - 14 Standard Test Method for Determination of Thermal Conductivity of Soil and Soft Rock. TPSYS20 is suitable for use by ISO certified laboratories.

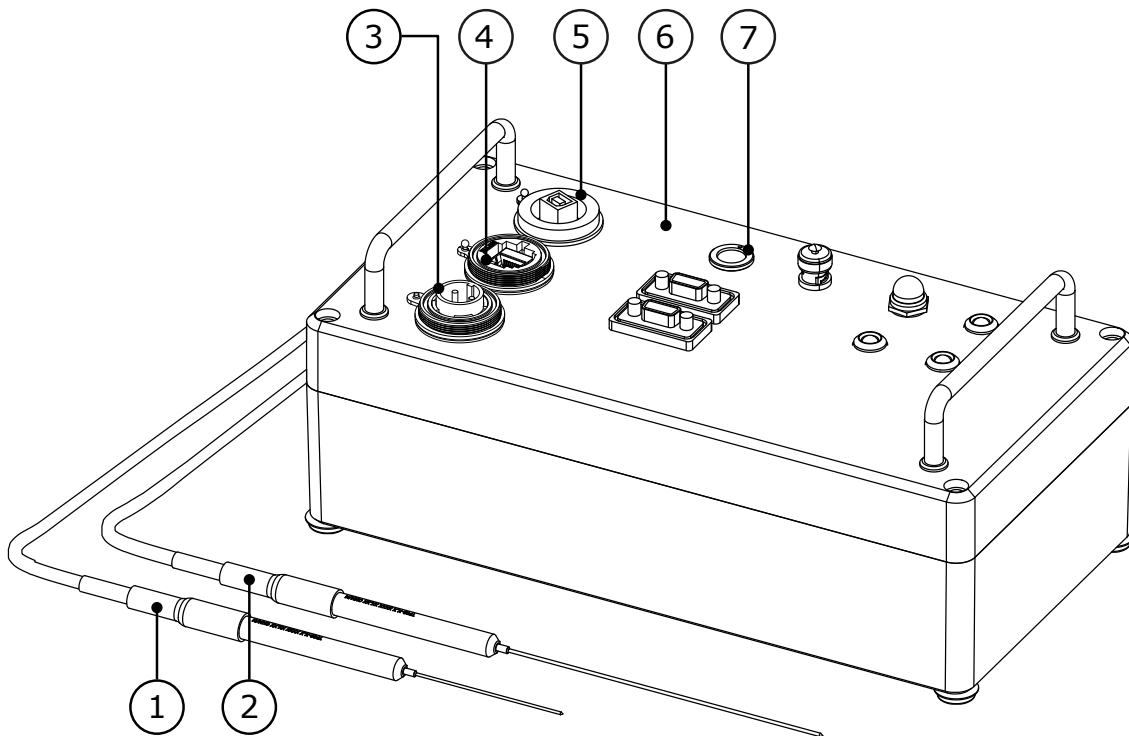

Figure 0.4 Overview of TPSYS20: the system includes needle model TP08 (1) or TP02 (2) and the MCU (6). The thermal needle probe must be connected to the MCU (7). The MCU is powered from a 12 VDC power source (3). Communication with the MCU can be done via an Ethernet port (4) or a USB port (5).

TP02 or TP08 probe

TPSYS20 is either delivered with a TP02 or a TP08 probe.

TP02 is equipped with a reference temperature junction, located in the tip of the needle. This allows the temperature difference between the heated section of the needle and the reference junction to be measured. The use of a reference junction makes the thermal conductivity measurement much less sensitive to specimen temperature drift. For more details see the TP02 brochure.

TP08 is a shorter needle, which makes it an excellent alternative when only small amounts of sample material are available. TP08 does not have a reference temperature junction. For more details see the TP08 brochure.

Alternative systems

TPSYS20 is primarily intended for laboratory use. For outdoor soil measurements Hukseflux recommends consulting the brochures of the more robust albeit less accurate FTN02, MTN02 and TNS02 systems designed for outdoor use.

User interface: MCU as a web server

TPSYS20 is controlled via a PC. The TPSYS20 MCU can be connected to a local area network via ethernet or directly to a PC via USB. The graphical user interface is available through a webpage and can be opened in any of the supported web browsers. No installation of software is required. The graphical user interface allows the user to configure measurement parameters, control measurements, view measurement progress and to view and download measurement results.

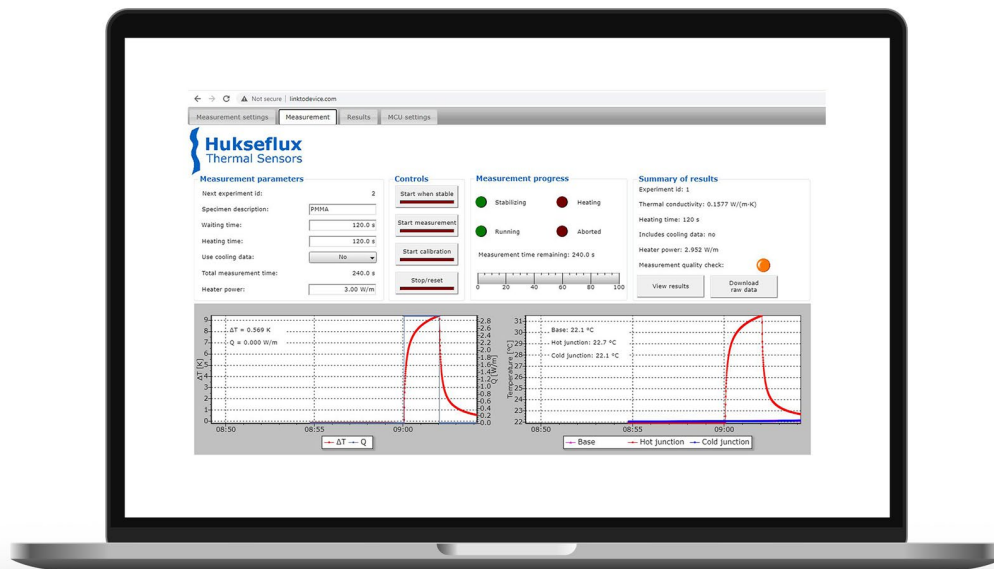

Figure 0.5 TPSYS20 graphical user interface, accessible through a web browser

TPSYS20 is a complete measuring system delivered with either probe TP02 or TP08. Besides this option, there are several accessories. See Chapter 1 Ordering and checking at delivery for a complete overview.

Accessories

For high accuracy calibration dedicated CRC01 Calibration Reference Cylinders are available. For insertion into hard material types or for casting into plastics, cement and backfill materials, GT Series Guiding tubes can be applied.



Figure 0.6 A CRC01 calibration reference cylinder containing a polymethylmethacrylate reference material for calibrating TP02 and TP08

See also

- our [range of sensors, systems and services for thermal conductivity measurement](#)
- robust alternative systems: [FTN02](#), [MTN02](#)
- [TP02 and TP08 thermal needle probes brochure and user manual](#)

1 Ordering and checking at delivery

1.1 Ordering TPSYS20

The standard configuration of TPSYS20 includes either a TP02 or a TP08 thermal needle probe.

- TPSYS20 with TP02 probe, order code TPSYS20-02
- TPSYS20 with TP08 probe, order code TPSYS20-08

1.2 Included items

Arriving at the customer, the TPSYS20 delivery should include:

- 1 x TPSYS20 Measurement and control unit (MCU)
- 1 x TP02 or TP08 thermal needle probe with connector and protective cover
- 1 x 12 VDC Power supply unit (PSU), with 4 interchangeable AC plugs
- 1 x USB-A to USB-B cable with Bulgin connector, 2 m
- 1 x reference material container with polyester fibres
- 5 x GT02 guiding tubes for TP02 or 5 x GT01 for TP08
- 1 x USB flash drive containing manual and data analysis tool
- 1 x carrying case
- 1 x product certificate



Figure 1.2.1 TPSYS20 system with its main components: MCU, TP02/TP08 sensor, carrying case, power supply, reference material container and a set of guiding tubes

Common accessories are:

- CRC01 - a calibration reference cylinder
- CR1000KD- a Campbell Scientific CR1000KD Keyboard/Display
- TP02 - a spare TP02 thermal needle probe
- TP08 - a spare TP08 thermal needle probe
- GT01 - a spare set of 5 guiding tubes for TP08
- GT02 - a spare set of 5 guiding tubes for TP02



Figure 1.2.2 *TPSYS20 is delivered with either a TP02 or TP08 thermal needle probe. Spare probes can be ordered as an accessory.*

2 Instrument principle and theory

TPSYS20's main components are a thermal needle probe (also known as a non-steady state probe or transient line-source probe) and a measurement and control unit (MCU). TPSYS20 is intended for the measurement of the thermal conductivity of the medium into which the thermal needle probe is inserted.

2.1 Operating principle of thermal needle probes

Thermal needle probes are used to determine the thermal conductivity by measuring the temperature response of a specimen to heat generated by the probe.

On a coarse level a thermal needle probe consists of a needle, a base and a cable with a connector used to connect the probe to the MCU. The needle contains a linear heater with a known electrical resistance per unit length (in Ω/m) and one or more temperature sensors at least one of which is located in the heated section of the needle. The heater and sensor connections to the cable are located in the base. Additionally, the base may contain a temperature sensor.

As an example, consider the TP02 and TP08 thermal needle probes. TP02 and TP08 needles contain a thermocouple with a hot joint located in the middle of the heated section of the needle. The base of TP02 and TP08 contains a reference junction with a Pt1000 resistance thermometer. For TP08 the heater runs along the length of the needle. For TP02 the heater runs along two-thirds the length of the needle, with the remaining one-third of the needle being unheated. The tip of the TP02 needle contains a cold junction. This allows TP02 to measure the temperature difference between the hot junction and the cold junction. TP08 does not have a second thermocouple or a cold junction. See Figure 2.1.1.

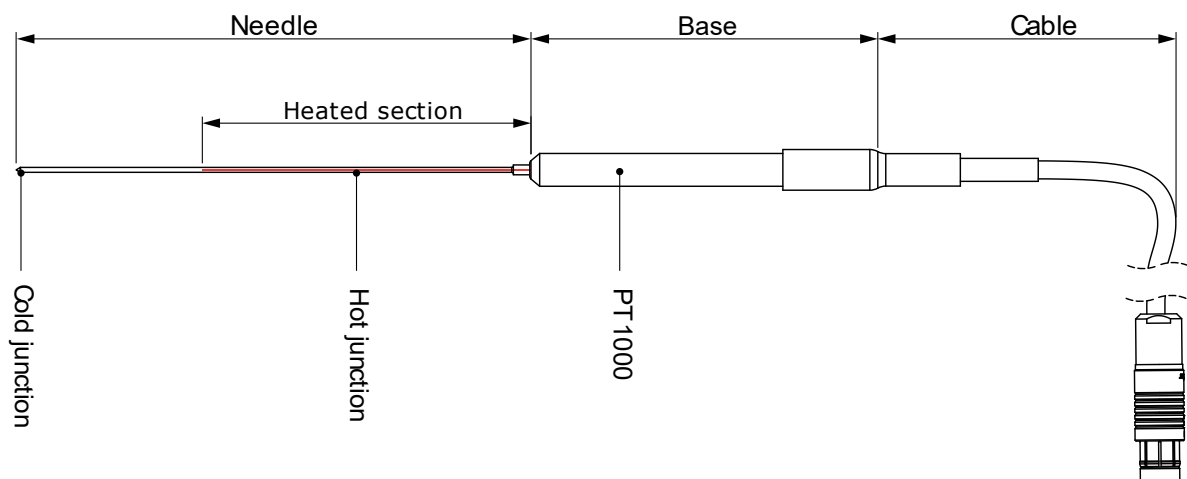

Figure 2.1.1 The main components of a thermal needle probe

To measure the thermal conductivity the needle is inserted into the specimen. By running a set current through the heater, the specimen will start to heat up. For a given amount of heat Q (in W/m) generated by the probe, the temperature of a specimen with a small thermal conductivity λ will increase more rapidly than the temperature of a specimen with a large thermal conductivity, as illustrated in Figure 2.1.2. The thermal conductivity is determined from the rate at which the temperature increases, or more precisely the slope of temperature-versus-logarithm-of-time curve (see Section 2.3 for more details). Similar arguments apply to the cooling of a specimen after the heater is switched off.

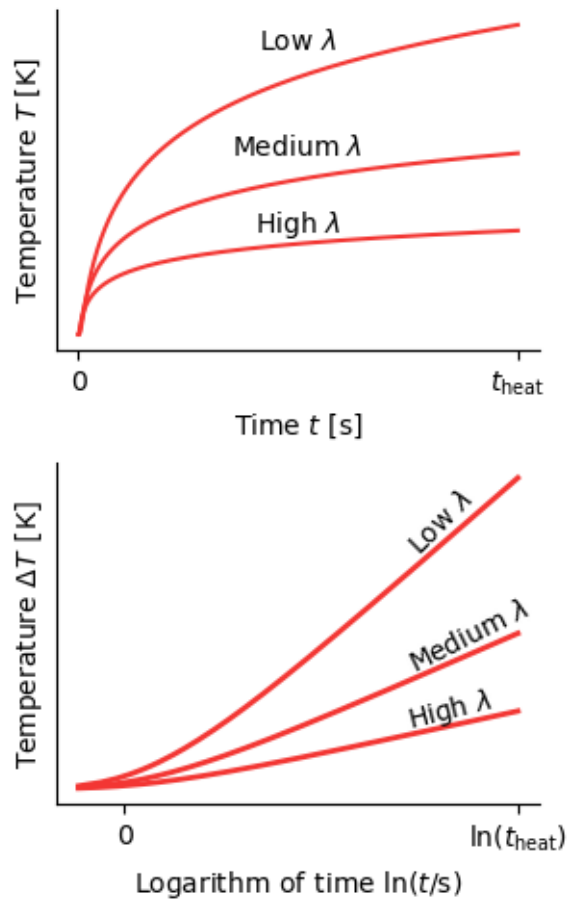

Figure 2.1.2 Thermal needle probes are used to determine the thermal conductivity λ measuring the temperature response to heat generated by the probe. For specimen with a lower thermal conductivity the temperature will increase more rapidly than for specimen with a higher thermal conductivity for the same amount of heat generated by the probe.

In a typical experiment first the temperature stability is measured during a time t_{wait} . Next, at time $t = 0$, the heater is switched on and the temperature response over a time interval t_{heat} is measured. At time $t = t_{\text{heat}}$ the heater is switched off. Optionally the temperature response during the cooling phase is measured. See Figure 2.1.3. Data collection, timing and switching of the heater is controlled by the MCU. See Section 2.2 for more details on the MCU.

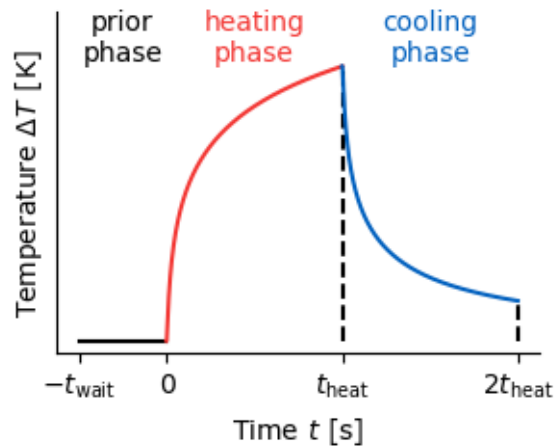

Figure 2.1.3 Illustration of a typical experiment. First the temperature stability is measured during a time t_{wait} . Next at time $t = 0$ the heater is switched on and the temperature response is measured during a time t_{heat} . At time $t = t_{heat}$ the heater is switched off. Recording of the cooling phase data over a time interval equal to the heating phase t_{heat} up to time $t = 2 \cdot t_{heat}$ is optional.

The thermal conductivity is determined by analysing the temperature response to the applied heating. See Section 2.3 for details on the measurement model and analysis.

2.2 Measurement and Control Unit

TPSYS20's MCU performs three tasks. Firstly, it performs measurements and collects data, secondly it processes that data and finally it provides a graphical user interface:

- The MCU controls the measurement. The MCU contains an adjustable constant current source that is used to power to the probe's heater. The MCU takes care of measurement timing and will switch the heater on and off at the times set by the user. The MCU contains a 24-bit ADC to measure the heater current and read the probe's temperature sensors. During an experiment the MCU will collect and store data.
- The MCU processes the data to display a preliminary result. After an experiment is complete the MCU will automatically perform a basic data analysis to obtain a preliminary value for the thermal conductivity λ . Hukseflux recommends downloading the data and performing a more sophisticated analysis to reach the final result (see Chapter 6).
- The MCU provides a graphical user interface (GUI) in the form of a webpage. TPSYS20's MCU acts as webserver. It can be connected to ethernet or USB. The GUI can be accessed through a web browser. The GUI provides a convenient way to set measurement parameters, start and monitor measurements and view preliminary results. It also provides users a way to retrieve data from the MCU. The user is referred to Chapter 4 for details on how to access the GUI from a PC.

The MCU consists of a Campbell Scientific CR1000X datalogger plus additional electronics. TPSYS20's MCU has multiple drives: the CPU drive and the CRD drive. The CPU drive contains the program that controls the measurement. The CRD drive contains the graphical user interface files and the measurement data.



Figure 2.2.1 TPSYS20's Measurement and Control Unit (MCU)

2.3 Measurement model and data analysis

When the heater is switched on at time $t = 0$ the temperature T will start to increase. After a brief transient period, the temperature during the heating phase is described by:

$$T \approx \frac{Q}{4\pi\lambda} \ln(t) + \text{constant} \quad \text{for } 0 \leq t \leq t_{\text{heat}}$$

Where λ is the thermal conductivity of the specimen, Q is the heater power per unit length of the heater and \ln denotes the natural logarithm function. Likewise, when the heater is switched off at $t = t_{\text{heat}}$ the temperature T will start to decrease. During the cooling phase, after a brief transient period, the temperature is described by:

$$T \approx \frac{Q}{4\pi\lambda} \ln\left(\frac{t}{t - t_{\text{heat}}}\right) + \text{constant} \quad \text{for } t \geq t_{\text{heat}}$$

The slope of the temperature-versus- $\ln(t)$ curve for the heating phase and similarly the slope of the temperature-versus- $\ln[t/(t-t_{\text{heat}})]$ curve for the cooling phase depends only on the thermal conductivity λ and the heater power Q . Therefore, by determining the slope of the curve, one can evaluate the thermal conductivity of the specimen:

$$\lambda = \frac{Q}{4\pi \times \text{slope}}$$

Where the heater power Q can be accurately evaluated from the heater's electrical resistance-per-unit-length R_L (in Ω/m) and the electrical current (in A) running through the heater by using Joule's law:

$$Q = R_L \times I^2$$

The slope can be determined using a linear regression analysis. Only the linear part of the curve should be included in the analysis. An initial transient portion of the curve is affected by factors other than the thermal conductivity λ of the specimen, such as the specimen thermal diffusivity and the diameter and heat capacity of the probe itself. This initial transient portion of the curve for $t < t_1$ should be excluded from the analysis.

Depending on the duration of the measurement and the thermal diffusivity of the specimen, for long times $t > t_2$ edge effects due to the finite diameter D_{specimen} of the specimen and end effects due to the finite length L_{heater} of the heater may start to affect the measurement data. If this is the case, then the portion of the data affected by such edge or end effects should also be excluded from the analysis. Only part of the data between a certain time t_1 and a certain time t_2 should be included in the analysis as illustrated in Figure 2.3.1.

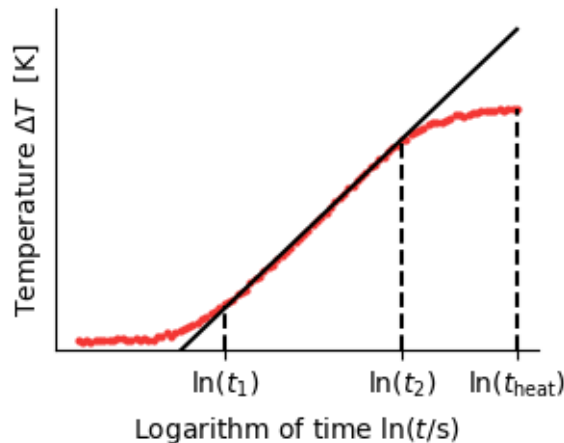

Figure 2.3.1 *Illustration of heating phase data used for analysis. Only data between time t_1 and time t_2 is used in the analysis. The transient period for $t < t_1$ and the period dominated by edge or end effects for $t > t_2$ are discarded. In the above illustration $t_2 < t_{\text{heat}}$, however this is not necessarily always the case.*

If the cooling phase data is recorded in addition to the heating phase data, the heating time t_{heat} must be adjusted such that edge or end effects only become relevant during the cooling phase. If edge or end effects already dominate during the heating phase, the cooling phase data must be discarded and only heating phase data can be used. Like the heating phase, the cooling phase is initially dominated by transient effects. This initial portion of the cooling phase data should likewise be discarded.

Since the thermal conductivity is calculated from the slope it is important that the temperature of the specimen is stable prior to the heating phase. Specimen temperature drift will bias the thermal conductivity. Data from the prior phase can be used to estimate the specimen temperature drift in °C/min. The absolute value of the temperature drift should be small compared to the temperature increase during the heating phase or the temperature decrease during the cooling phase.

If the temperature response during the cooling phase was measured the thermal conductivity λ_h calculated from the heating phase data and the thermal conductivity λ_c calculated from the cooling phase data can be averaged:

$$\lambda = \frac{1}{2} (\lambda_h + \lambda_c)$$

The advantage of measuring the cooling phase in addition to the heating phase is that specimen temperature drift affects the calculated thermal conductivity from the heating phase and the cooling phase in the opposite direction, therefore by averaging the results, the effect of specimen temperature drift is minimized.

More details about the theory of thermal needle probes can be found in Appendix 8.1. TPSYS20 is provided with a data analysis tool in the form of an MS Excel sheet that aids in the analysis of thermal conductivity data. The use of the data analysis tool is explained in Chapter 6.

3 Specifications

3.1 Specifications of TPSYS20

TPSYS20 is a high accuracy measuring system for measuring the thermal conductivity of specimens. TPSYS20 specifications are listed in Table 3.1.1. TPSYS20 is delivered with either a TP02 or TP08 thermal needle probe. TP02 and TP08 can also be ordered separately. TP02 and TP08 specifications are listed in table 3.1.2.

Table 3.1.1 *Specifications of TPSYS20 (continued on next page)*

TPSYS20 SPECIFICATIONS	
Description	thermal conductivity measuring system
Measurand	thermal conductivity
Measurand in base SI units	thermal conductivity in W/(m·K)
Rated measuring range	0.1 to 6.0 W/(m·K)
Measurand	specimen temperature
Measurand in base SI units	specimen temperature in °C
Optional measurand	thermal resistivity
Measurand in base SI units	thermal resistivity in m·K/W
Rated measuring range	0.16 to 10 m·K/W
Included items	<ul style="list-style-type: none"> • TPSYS20 Measurement and control unit (MCU) • TP02 or TP08 thermal needle probe with connector and protective cover • 12 VDC Power supply unit (PSU), with 4 interchangeable AC plugs • USB-A to USB-B cable with Bulgin connector • Reference material container with polyester fibres • Carrying case • USB flash drive containing manual and data analysis tool • Product certificate
Compatible test methods	<ul style="list-style-type: none"> • ASTM D5334 – 14 Standard Test Method for the Determination of Thermal Conductivity of Soil and Soft Rock by Thermal Needle Probe Procedure • IEEE 442-2017 IEEE Guide for Thermal Resistivity Measurements of Soils and Backfill Materials • ASTM D5930 – 17 Standard Test Method for Thermal Conductivity of Plastics by Means of a Transient Line-Source Technique
Storage and transport	
Gross weight TPSYS20 system including carrying case and packaging	approx. 10 kg
Net weight TPSYS20 system including carrying case	approx. 9 kg
Carrying case TPSYS20 system	case of 480 mm x 385 mm x 190 mm
Limiting storage and transport temperature	-20 to +80 °C
Storage	The thermal needle probe and MCU should be stored in a dry place. The thermal needle probe should be stored with protective cap in place. TPSYS20 MCU should be stored with the dedicated dust caps placed on connectors.

Table 3.1.1 Specifications of TPSYS20 (continued from previous page)

TPSYS20 MCU SPECIFICATIONS	
Compatible Thermal Needle Probes	<ul style="list-style-type: none"> • TP02 • TP08
Operating voltage	10 to 16 VDC
Recommended operating voltage	12 VDC
Typical current	100 to 500 × 10 ⁻³ A
Max. current	1 A
ON/OFF switch and Power ON LED	red Power ON LED is on when power is supplied to MCU
Sample rate	2 Samples / s
Data tables	RawData Results
Net weight MCU	3.80 kg
IP rating MCU	IP54
MCU Datalogger	Campbell Scientific CR1000X Measurement and Control Datalogger
Datalogger specifications	see CR1000X manual and specification sheet available from https://www.campbellsci.com/cr1000x
Internal battery	AA, 2.4 A·hr, 3.6 VDC (Tadiran, TL-5903/S) for battery-backed memory and clock only
Internal battery replacement interval	3 years
Internal memory card	ATP, 2 GB MicroSDHC Card Class 10, UHS-1 U1, SLC
User interface	
Connection	via LAN or "Ethernet over USB"
MCU user interface	web page via a web browser
Web browser requirements	HTML 5 support
Supported web browsers	Chrome 10 Firefox 4 Internet Explorer 9 Opera 11 Safari 5 (and later)
12 VDC connector	
Connector type on MCU	Bulgin Standard Buccaneer®, PX0735/P, 2 pole connector with pins
Sensor connector	
Connector type on MCU	Fischer, DEE 104 A055-130, 9 pin, female connector
Thermal fuse current limit	1800 × 10 ⁻³ A
Purpose	connecting a compatible thermal needle probe
USB connector	
Connector type on MCU	female USB-B
Maximum USB cable length	3.0 m
Ethernet connector	
Connector type on MCU	RJ45 (shielded)
Isolation/protection	magnetic isolation TVS surge protection
Recommended ethernet cable type	CAT6A S/FTP
Maximum ethernet cable length	30 m
Trigger input connector	
Connector type on MCU	female BNC connector
Input impedance	5 kΩ
Pull-up resistance	100 kΩ to 5 V
Max. input voltage	10 V
Protection	TVS surge protection
Minimum trigger pulse width	5 ms
RS232 connector	
Connector type on MCU	female DB9 connector

Table 3.1.1 Specifications of TPSYS20 (continued from previous pages)

CS I/O connector	
Connector type on MCU	female DB9 connector
Purpose	for connecting TPSYS20 MCU to optional Campbell Scientific CR1000KD Keyboard/Display (not included with TPSYS20)
POWER SUPPLY SPECIFICATIONS	
Power supply model	Friwo, FOX30-X, 12V/2500mA, FW8030/12, 1898155
Input voltage	100 or 240 VAC
Frequency	50 Hz or 60 Hz
Input plug type	Type A/B (USA), Type C/F (EU), Type G (UK), Type I (AU)
Output voltage	12 VDC
Output current	2.5 A
Output cable length	approx. 1.75 m
Output connector type	Bulgin Standard Buccaneer®, PX0736/S, 2 pole connector with sockets
REFERENCE MATERIAL CONTAINER	
Reference Material	glycerol, > 96% pure (not included)
Fibres to inhibit convection	polyester fibres
Weight (glycerol not included)	0.180 kg
Volume	1.0 L
Reference thermal conductivity	0.285 W/(m·K) at 25 °C
Uncertainty	± 5 % (coverage factor k = 2)

Table 3.1.2 Specifications of TP02 and TP08 thermal needle probes (continued on next page)

THERMAL NEEDLE PROBE SPECIFICATIONS		
Model	TP02	TP08
Cable and connector		
Cable length	2.5 m	2.5 m
Connector type	Fischer, S 104 A055-130, 9 pin, male connector with internal part E3 104.2/6.7 + B	
Probe dimensions		
Needle diameter	1.5 mm	1.2 mm
Needle length	150 mm	70 mm
Base diameter	10 mm	10 mm
Weight (including cable)	0.3 kg	0.3 kg
Heater		
Heater resistance per unit length	specified for each instrument individually	
Nominal heater resistance per unit length	85 Ω/m	85 Ω/m
Nominal heater resistance (including lead wire resistance)	11 Ω	8 Ω
Heater length	100 ± 2 mm	70 ± 2 mm
Base temperature sensor		
Type	resistance thermometer, Pt1000, IEC 751:1983 class B	
Accuracy	± (0.005 × T + 0.30 °C) T in °C	
Needle temperature sensor		
Type	thermocouple, type K, IEC 60584-1:2013 class 2	

Table 3.1.2 Specifications of TP02 and TP08 thermal needle probes (continued from previous page)

Cold junction	in needle tip	none
Specimen requirements		
Recommended specimen diameter	> 100 mm	> 100 mm
Recommended specimen length	> 160 mm	> 80 mm
Recommended minimum specimen volume	> 1.3 L	> 0.65 L
Operating Conditions		
Rated operating temperature range	-55 to +180 °C	
IP rating	IP68 (needle and base) IP67 (entire probe)	

3.2 Dimensions of TPSYS20

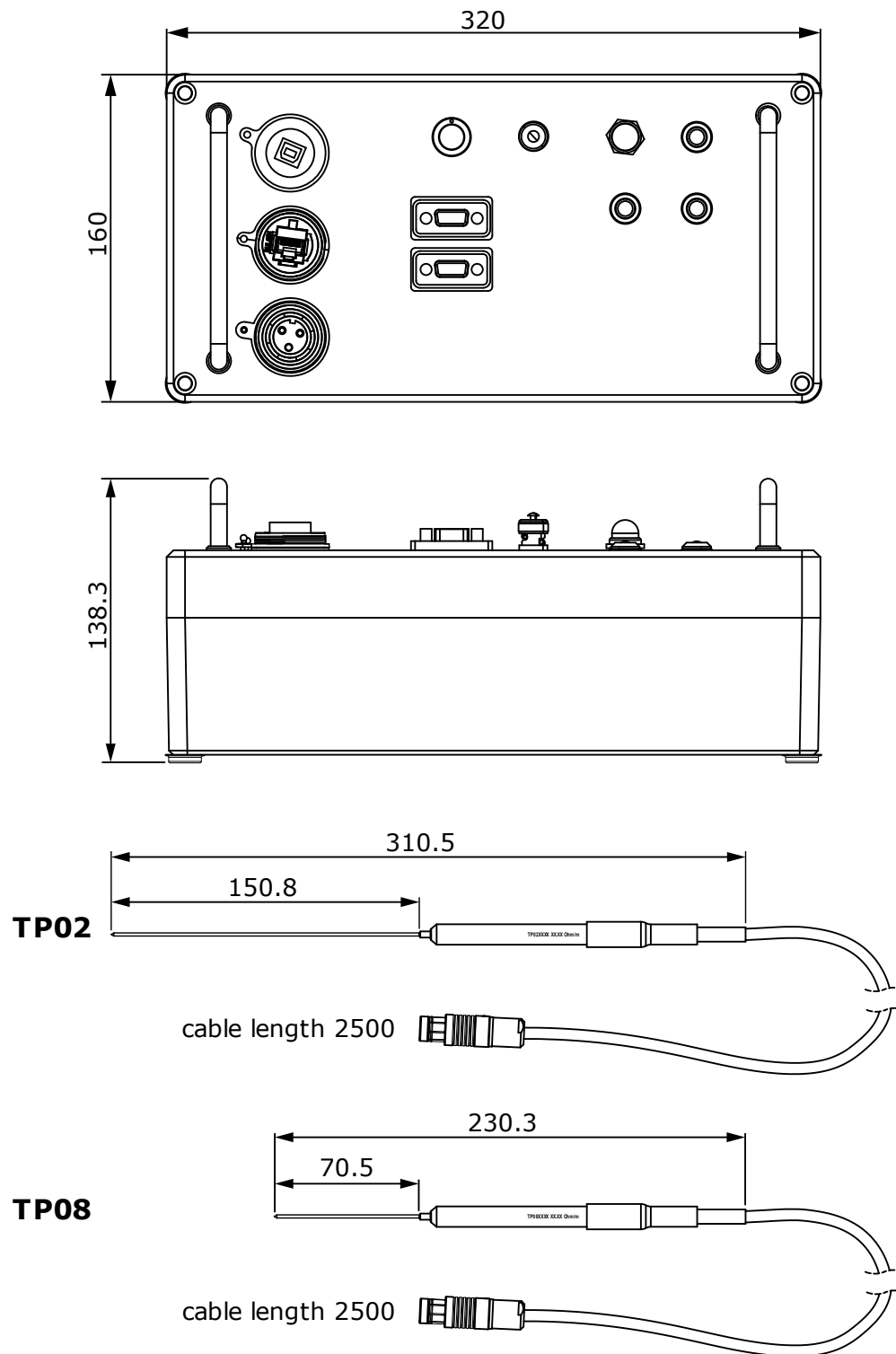

Figure 3.2.1 Dimensions of TPSYS20 in $\times 10^{-3} m$

4 Installation and connection

This chapter describes how to set up TPSYS20 and to prepare the system for measurements. Before starting, it is recommended to check if all components are present (see Chapter 1). Preparation of the system consists of four steps:

1. hardware installation,
2. opening the graphical user interface,
3. setting the measurement system clock, and
4. setting the net frequency filter.

4.1 Hardware installation

The following hardware is needed for installation:

- power supply unit PSU
- TPSYS20 MCU
- TP02 or TP08 non-steady-state probe
- either a PC with a USB port or a PC connected to a Local Area Network (LAN)
- USB cable or ethernet cable

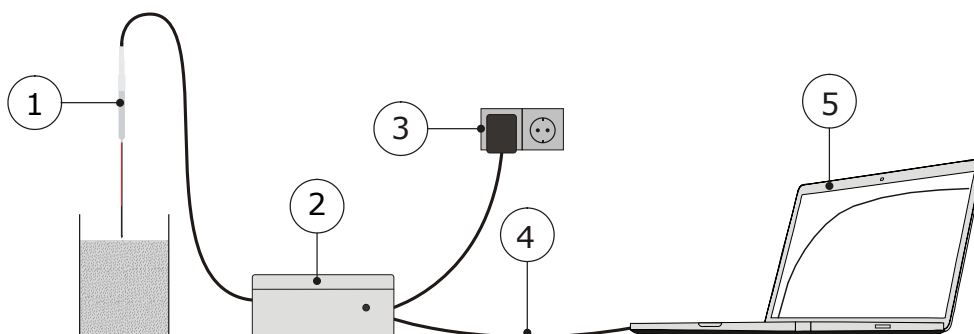

Figure 4.1.1 The components needed for hardware installation are: the thermal needle probe (1), the TPSYS20 MCU (2), the PSU (3), a USB or ethernet cable (4) and a laptop or PC with an ethernet connection or a USB port (5)

TPSYS20 is primarily intended for laboratory use. For the highest accuracy measurements, the system is preferably setup in an environment with a stable temperature away from direct sunlight, open windows and doors, air conditioning or heating.

TPSYS20 is operated in conjunction with a PC. There are two options to connect the TPSYS20 MCU: either the TPSYS20 MCU is connected to a local area network via ethernet or the TPSYS20 MCU is connected directly to a PC via USB. To connect to a PC, connect the 'USB' port on the MCU to a USB port on the PC using a UBS A to USB B cable. To use any PC in a LAN, connect the MCU to the LAN using an ethernet cable. Plug this cable

into the 'Ethernet' connector on the MCU and into the appropriate connector on a switch or router in the LAN. When connecting TPSYS20's MCU the cable requirements in the specifications chapter must be observed.

Connect TPSYS20 MCU to the power supply using the accompanying power adapter. Plug the adapter into your power outlet and connect to the '12VDC' connector on the MCU.

Finally connect the TP02 or TP08 probe to the TPSYS20 MCU.

Turn the system ON by pressing the 'Power' button on the MCU. The 'Power ON' LED should light up. You are now ready to connect to the system. Following the instructions in Section 4.2, you should now be able to access the interface and all data on the MCU.

NOTICE

To avoid ground loops, do not connect the ethernet port and the USB port of the TPSYS20 MCU at the same time.

4.2 Opening the graphical user interface

TPSYS20 is operated using a web-based graphical user interface, which is pre-loaded on the MCU. This section explains how to get access to the user interface via either a USB or ethernet connection. For more setup options, see the appendix on advanced settings.

To connect to the MCU, there are two options: a direct ethernet connection or an ethernet over USB connection.

4.2.1 USB connection

To use this option, TPSYS20 MCU should be connected directly to a USB port on the PC. When using a USB connection, the Microsoft RNDIS protocol will be used to provide a 'virtual ethernet link' or 'ethernet over USB'.

Use of the ethernet over USB connection requires the Microsoft RNDIS drivers to be installed. The drivers should either be installed by default or install automatically upon connecting TPSYS20 MCU to the PC. If the drivers are not automatically installed, install the USB drivers using the Campbell Scientific Device Configuration Utility, see the appendix.

To access the graphical user interface, open a compatible web browser (see specifications chapter for a list of compatible web browsers) and enter the following URL into the address bar: <http://www.linktodevice.com>.

Alternatively, one can use the IP address to open the graphical user interface. To do so enter 'http://' followed by the IP address into the address bar. By default, the IP address is 192.168.66.1, such that <http://192.168.66.1> should be entered into the address bar.

For easy access it is recommended to bookmark the URL in the web browser or to create a shortcut on the desktop.

4.2.2 Ethernet connection

To use this option, the MCU and the PC should be connected to the same LAN. The MCU will be assigned an IP address automatically.

To access the graphical user interface, open a compatible web browser (see specifications chapter for a list of compatible web browsers) and enter the following URL into the address bar: http://tpsys20_nnnnnnn, where nnnnnnn must be replaced by the 7 digit serial number of the MCU. The web browser should now open the user interface. The MCU's serial number can be found on the product certificate and on the MCU itself.

If the network does not allow for systems to assign their own name, the IP address can be used to open the graphical user interface. To do so enter 'http://' followed by the IP address into the address bar of the web browser.

The IP address of the MCU can be found using either a general purpose IP scanner, the Campbell Scientific LoggerLink Mobile Apps for iOS and Android systems, available from <https://www.campbellsci.com/loggerlink> (see Appendix 8.8) or the Campbell Scientific Device Configuration Utility available from <https://www.campbellsci.com/devconfig> (see Appendix 8.9).

Once a connection to the TPSYS20 MCU has been established, it is recommended to bookmark the URL in the web browser or to create shortcut on the desktop.

4.2.3 Logging into the TPSYS20 MCU

To make sure the TPSYS20 MCU can only be controlled by the authorised users on a shared network, first time use in a new browser or PC requires the correct credentials. A pop-up will appear asking you to enter your credentials. The credentials are:

Username: TPSYS20

Password: serial number of the TPSYS20 MCU

4.3 Setting the system clock

Next the system clock must be set. To set the clock: in the interface select the **MCU settings** tab, click the **clock settings** button. This will open a new window. Click the **Sync MCU clock** button. This will synchronize the MCU time to the PC time. See Figure 4.3.1.

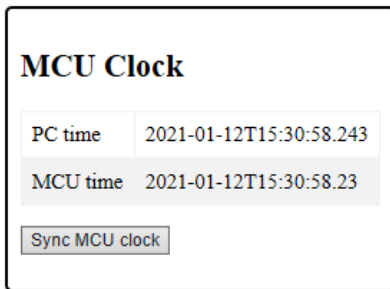

Figure 4.3.1 Synchronizing the MCU clock with the PC clock

4.4 Setting the net frequency filter

To complete the system setup, the net frequency filter must be set for the region in which the system is used. To set the net frequency filter: in the interface select the **MCU settings** tab, in the **Net frequency filter** box select the **Net frequency filter** drop down list and select the net frequency for your region (e.g. 50 Hz for Europe or 60 Hz for North America). After setting the net frequency the MCU will restart. This may take a minute. Afterwards the web interface may have to be refreshed.

4.5 Overview of the graphical user interface

At the top of the graphical user interface there are four tabs:

- The **Measurement settings** tab where the user can set the parameters of the thermal needle probe, the calibration reference and the stability criterion that are to be used for the measurements.
- The **Measurements** tab from where the user can start and monitor measurements.
- The **Results** tab from where the user can view the results once a measurement has completed.
- The **MCU settings** tab from which the user can set the MCU clock, control the trigger input, restart the MCU, wipe the MCU data tables and set the net frequency filter.

It is recommended that the user takes a brief moment to browse through the different tabs and gets familiar with their content before proceeding to make measurements.

4.5.1 Measurement settings tab

The **Measurement settings** tab is shown in Figure 4.5.1.1. The measurement settings tab has four boxes: the **Thermal needle probe** box, the **Calibration reference** box, the **Temperature stability assessment** box and the **Information** box.

In the **Thermal needle probe** box the user must set the parameters of the thermal needle probe that is being used. These parameters have a direct impact on the measurement and measurement results and must be set such that parameters match those on the product certificate prior to performing measurements. If a different thermal needle probe is connected to the MCU the parameters must be updated. See also Section 5.1.

NOTICE

Make sure to program the probe parameters into the MCU before starting a measurement. Failure to program the correct probe parameters into the MCU causes the measurement results to be invalid.

In the **Calibration reference** box the user can set the thermal conductivity reference value of the calibration reference. The user can either select predefined values or enter custom values. The data is used to compare the measured thermal conductivity to the thermal conductivity reference value when performing a calibration measurement. The calibration reference data must be set prior to starting a calibration measurement. See also Section 5.2 and Appendix 8.4.

The **Temperature stability assessment** box allows the user to set the temperature stability criterion. When using the **Start when stable** button in the **Measurements** tab, the MCU will automatically start a measurement once the temperature stability criterion has been met. Stricter stability criteria lead to more accurate measurements; however it will take longer for the temperature to settle. In some cases, if the temperature of the environment in which TPSYS20 is used is not stable enough, the criterion may never be met. In that case a less strict criterion can be used at the expense of measurement accuracy.

The **Information** box contains links to the Hukseflux website and the TPSYS20 manual.

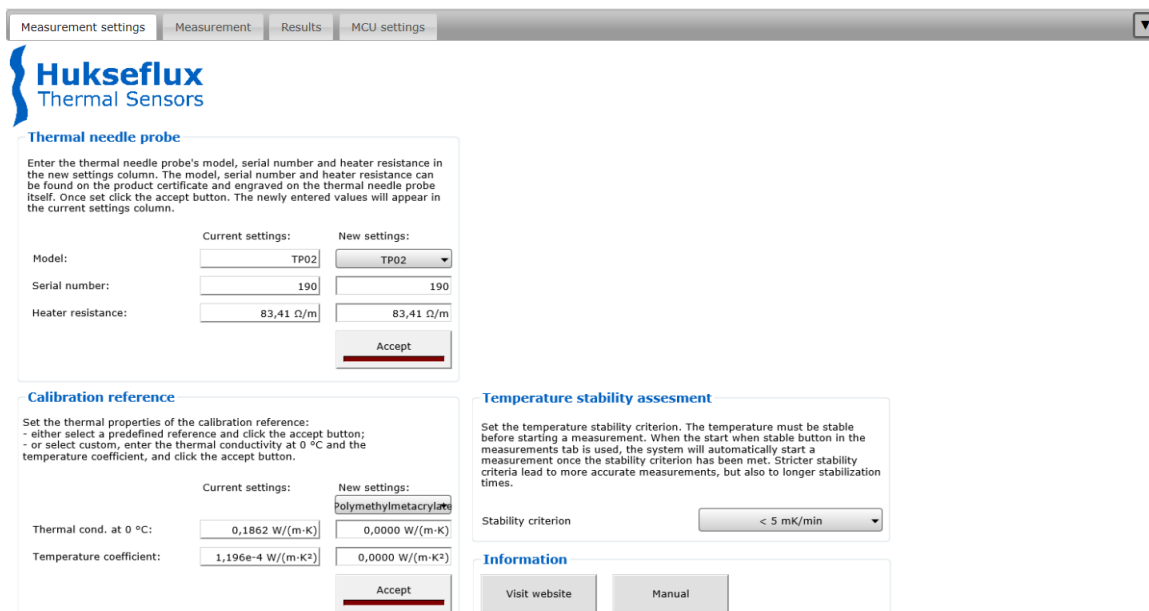

Figure 4.5.1.1 The measurement settings tab of the TPSYS20 graphical user interface.

4.5.2 Measurements tab

The **Measurements** tab is shown in Figure 4.5.2.1. The measurements tab allows the user to control and monitor measurements. The **measurements** tab has four boxes: **Measurement parameters**, **Controls**, **Measurement progress** and **Summary of results**.

The **Measurement parameters** box allows the user to set the measurement parameters such as the **specimen description**, the **waiting time**, the **heating time**, whether to **use cooling data** and the **heater power**. The measurement parameters must be set before the measurement. Changing the parameters while a measurement is running will have no effect on the current measurement and will only affect the next measurement.

The **Controls** box allows the user to start measurements or calibration measurements and to stop measurements.

The **Measurement progress** box displays the status of a measurement. The indicators show if the system is waiting for the temperature to become stable enough to start a measurement, if a measurement is running, if the heater is on, and if the user has aborted the measurement. It also shows the remaining measurement time while a measurement is running.

The **Summary of results** box gives a brief overview of the results. For more detailed results view the **Results** tab.

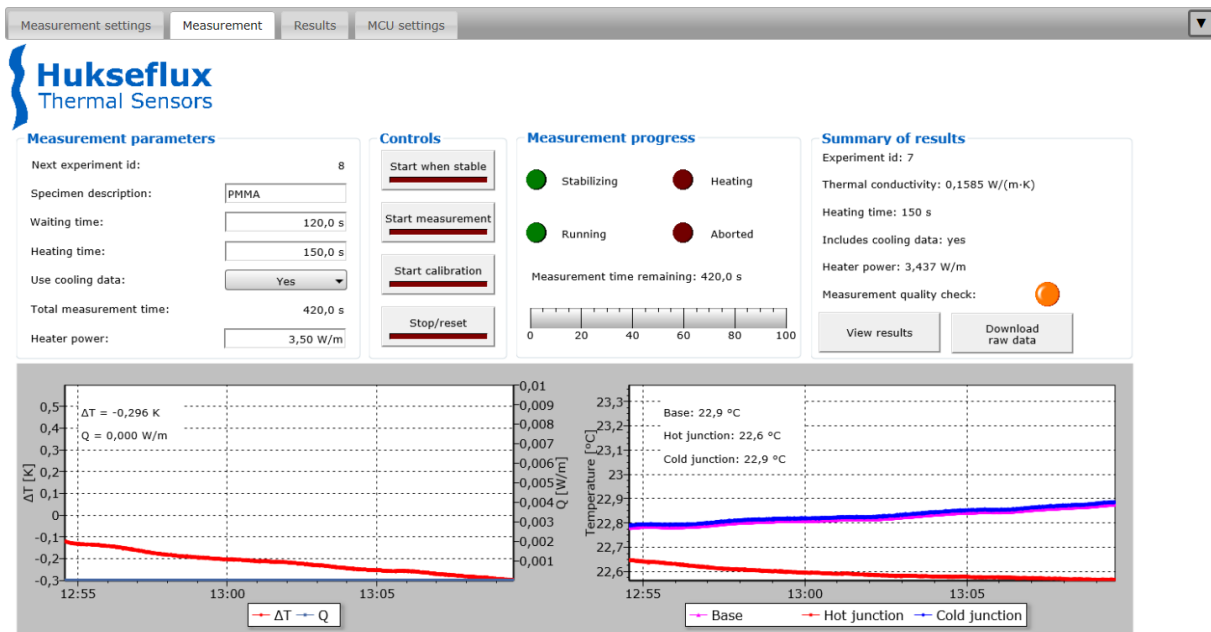

Figure 4.5.2.1 The measurement tab of the TPSYS20 graphical user interface

4.5.3 Results

The **Results** tab is shown in Figure 4.5.3.1. The **Results** tab displays the results from the latest measurement that has been completed. The **Results** tab contains three boxes: **Results**, **Measurement quality checks** and **Calibration summary**.

The **Results** box shows a detailed overview of the measurement results and the measurement parameters that were used for the last measurement. The **Results** box also allows the user to:

- download an overview of all results (i.e. not just the most recent result, but also previous results);
- download the raw data from the most recent measurement; and
- open the record browser to browse through previous results and download raw data from previous measurements.

The **Measurement quality checks** box lists the results of a number of quality checks performed on the measurement parameters set by the user and on the measurement data. If a measurement quality check fails it may indicate that something is amiss with the measurement. It is recommended that the user critically reviews the data. The measurement quality checks are described in more detail in Chapter 5.

The **Calibration summary** box shows the results of the calibration if the last measurement was a calibration measurement. If the last measurement was not a calibration measurement, the box will not display any data other than the measured thermal conductivity.

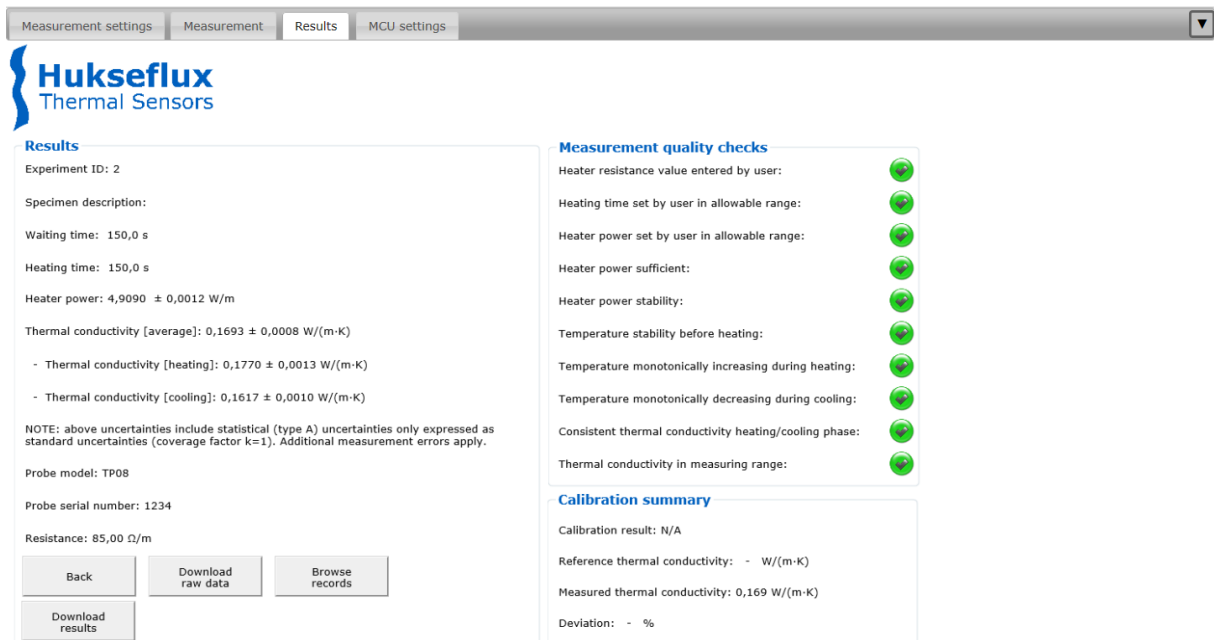

Figure 4.5.3.1 The results tab of the TPSYS20 graphical user interface

4.5.4 MCU settings

The **MCU settings** tab is shown in Figure 4.5.4.1. The **MCU settings** tab contains four boxes: **Erase/Restart**, **External trigger**, **Clock**, **MCU status**.

The **Erase/Restart** box allows the user to erase all measurement records or to restart the MCU.

The **External trigger** box allows the user to set the response to an external trigger pulse. See also Appendix 8.5.

The **Clock** box allows the user to view and set the MCU time. See also Section 4.3.

The **MCU status** box gives an overview of the MCU status, such as the power supply voltage, the internal battery voltage, the MCU temperature and the datalogger OS.

The **Net frequency filter** box allows the user to set the net frequency filter for their region (either 50 or 60 Hz).

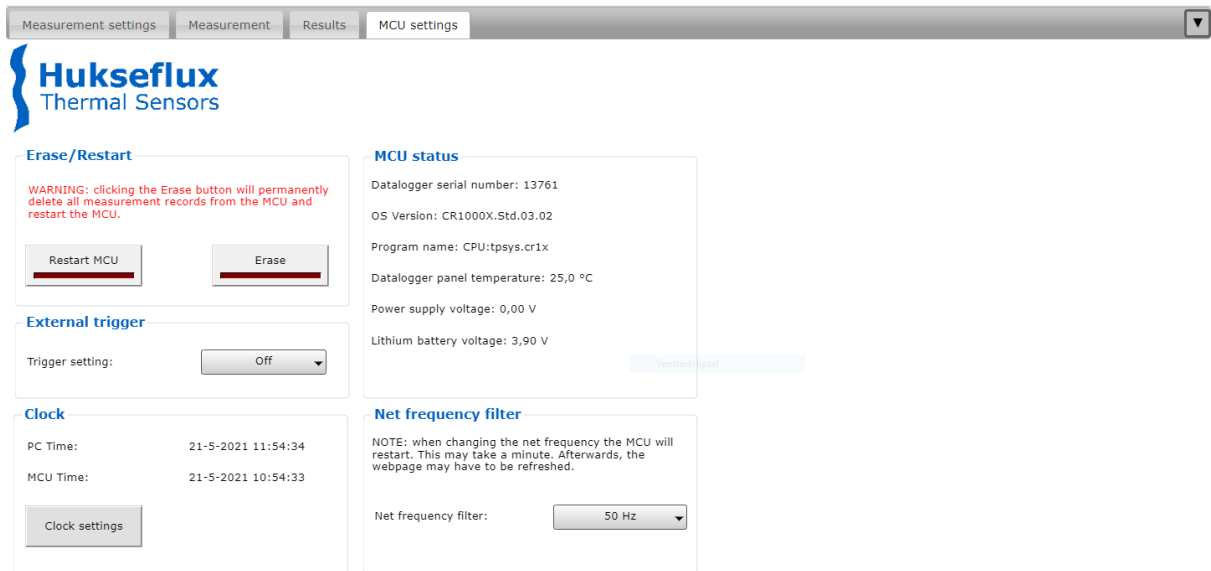

Figure 4.5.4.1 The MCU settings tab of the TPSYS20 graphical user interface

5 Making measurements

This chapter gives instructions on how to set the thermal needle probe parameters, how to perform calibration measurements, how to make thermal conductivity measurements using TPSYS20 and how to retrieve the results and raw data. It is assumed that the user has completed the installation and setup steps described in Chapter 4.

5.1 Setting the thermal needle probe parameters

The thermal needle probe parameters must be entered into the software prior to performing any measurements. Whenever a different thermal needle probe is connected to the MCU (e.g. when a TP02 is exchanged for a TP08 or vice versa) the thermal needle probe parameters in the software must be updated. Failure to enter the thermal needle probe parameters correctly will lead to invalid measurement results. To enter the thermal needle probe parameters, complete the following steps:

1. Open the web interface and select the **Measurement settings** tab.
2. Enter the following parameters in the **Thermal needle probe** box in the **New settings** column (see Figure 5.1.1):
 - **Model** – e.g. TP02 or TP08.
 - **Serial number** – the thermal needle probe’s serial number can be found on the product certificate or on the base of the probe.
 - **Heater resistance** – the probe’s heater resistance in Ω/m can be found on the product certificate or on the base of the probe.
3. Check if the thermal needle probe parameters have been entered correctly, if necessary, correct them. Once the parameters are correct click the **Accept** button. Upon clicking the **Accept** button the parameters will be transferred from the **New setting** to the **Current settings** column.

Thermal needle probe

Enter the thermal needle probe's model, serial number and heater resistance in the new settings column. The model, serial number and heater resistance can be found on the product certificate and engraved on the thermal needle probe itself. Once set click the accept button. The newly entered values will appear in the current settings column.

	Current settings:	New settings:
Model:	<input type="text" value="TP08"/>	<input type="text" value="TP08"/>
Serial number:	<input type="text" value="1234"/>	<input type="text" value="1234"/>
Heater resistance:	<input type="text" value="85,00 <math>\Omega/m</math>"/>	<input type="text" value="85,00 <math>\Omega/m</math>"/>
		<input type="button" value="Accept"/>

Figure 5.1.1 The thermal needle probe box in the measurement settings tab

NOTICE

Make sure to program the probe parameters into the MCU before starting a measurement. Failure to program the correct probe parameters into the MCU causes the measurement results to be invalid.

5.2 Thermal needle probe calibration

At the start of a measurement campaign it is recommended to perform a calibration measurement to confirm that the system is working properly. By some measurement standards calibration is required (see Appendix 8.4). To perform a calibration measurement a calibration reference material with a known thermal conductivity is required. For a list of common calibration reference materials refer to Appendix 8.4.1. It may be useful to select a calibration reference material with a thermal conductivity value that is comparable to that of the specimen that are to be measured after the calibration. Avoid using non-viscous liquids as a calibration reference material, as they are prone to convection causing biases and inaccuracies. When a calibration measurement is made, the measured thermal conductivity of the calibration reference is compared to the known thermal conductivity value of the calibration reference. Depending on the deviation that is found and/or the test standard that the user would like to follow, the user may want adjust the measurements by a calibration factor (refer to Appendix 8.4 for more details).

5.2.1 Setting the calibration reference parameters

Before making a calibration measurement the known thermal conductivity value of the calibration reference must be set in the MCU. This allows the MCU to compare the measured thermal conductivity to the known thermal conductivity value of the calibration reference. To set the thermal conductivity value of the calibration reference complete the following steps:

1. Open the web interface and select the **Measurement settings** tab.
2. In the **Calibration reference** box under the **New settings** column:
 - *either* select a predefined calibration reference from the drop down box (the other fields will be ignored);
 - *or* select custom from the drop down box and enter the **Thermal cond. at 0 °** as well as the **Temperature coefficient**.
3. Check if the calibration reference parameters have been set correctly and click **Accept**. Upon clicking **Accept** the system will set the values in the **Current settings** column if a predefined calibration reference was selected, or the system will copy the values from **New settings** columns if a custom calibration reference was selected.

Calibration reference

Set the thermal properties of the calibration reference:
 - either select a predefined reference and click the accept button;
 - or select custom, enter the thermal conductivity at 0 °C and the temperature coefficient, and click the accept button.

	Current settings:	New settings:
Thermal cond. at 0 °C:	<input type="text" value="0,1862 W/(m·K)"/>	<input type="text" value="0,0000 W/(m·K)"/>
Temperature coefficient:	<input type="text" value="1,196e-4 W/(m·K²)"/>	<input type="text" value="0,0000 W/(m·K²)"/>
		<input type="button" value="Accept"/>

Figure 5.2.1.1 The calibration reference box in the measurement settings tab

5.2.2 Performing a calibration measurement

To perform a calibration measurement complete the following steps:

1. Insert the entire needle of the thermal needle probe into the calibration reference material. Make sure that the probe cannot move during the measurement. If necessary, use a lab stand to fix the probe. Furthermore, minimize thermal contact resistance between the needle and the calibration reference. Avoid air gaps between the needle and the calibration reference and if necessary, reduce thermal contact resistance by using a thermal contact agent such as glycerol or thermal paste.
2. Open the web interface and select the **Measurements** tab.
3. In the **Measurements** tab in the **Measurement parameters** box set the following parameters:
 - **Specimen description** – enter a description by which the specimen can be identified.
 - **Waiting time** – it is recommended to use a waiting time of at least 60 s. The default value is 120 s.
 - **Heating time** – typical heating times are between 20 and 180 s. Specimen with a lower thermal conductivity require a larger heating time. The default value is 120 s.
 - **Use cooling data** – Using cooling data makes the measurement less sensitive to specimen temperature drift and therefore more accurate, but also increases the total measurement time, thus making the measurement process more time consuming.
 - **Heater power**. The heater power can be set between 0.01 W/m and 5.0 W/m. Specimen with a higher thermal conductivity require a higher heater power. The default value is 1.0 W/m.
4. Wait for the **Temperature difference** signal to become sufficiently stable. The **Temperature difference** signal can be found in the left graph on the **Measurements** tab. The required stability depends on the required accuracy, the

measurement parameters and the thermal conductivity of the calibration reference. As a starting point the temperature drift should be less than 10 mK/min.

5. When the **Temperature difference** is stable click the **Start calibration** button in the **Controls** box.
6. Once the calibration measurement has completed select the **Results** tab and view the calibration results in the **Calibration summary** box. The calibration result is ok if the deviation is less than 5 %.

Calibration summary

Calibration result: pass

Reference thermal conductivity: 0,189 W/(m·K)

Measured thermal conductivity: 0,181 W/(m·K)

Deviation: -0,04 %

5.3 Thermal conductivity measurements

This section describes how to prepare the specimen and how to make a thermal conductivity measurement.

5.3.1 Specimen preparation

The minimum recommended specimen dimensions for use with TP02 and TP08 are illustrated in Figure 5.3.1.1. These minimum recommended specimen dimensions will give accurate measurement results for a wide range of specimen.

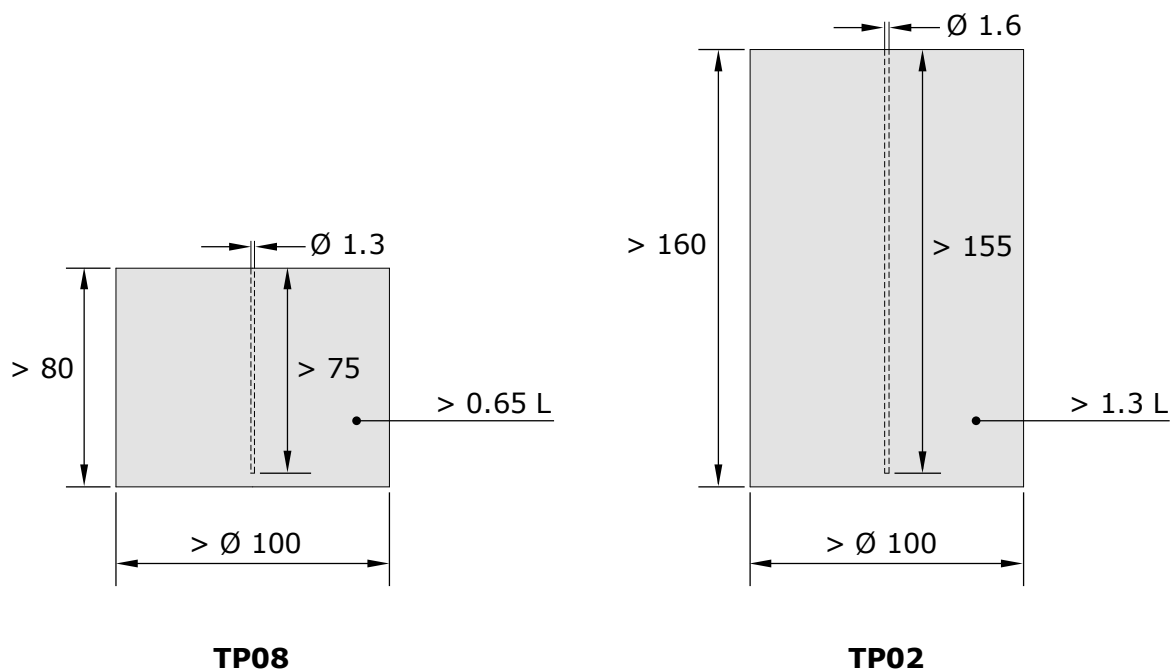

Figure 5.3.1.1 Minimum recommended specimen dimensions for TP02 and TP08; dimensions in millimetres and in litres

Depending on the required accuracy, the thermal properties of the specimen and the available specimen material the user may deviate from the minimum recommended specimen dimensions, e.g.:

- If the specimen has a low thermal diffusivity, smaller diameter specimen may be used.
- If only small amounts of specimen material are available, the user may be forced to accept a lower measurement accuracy to be able to still make a measurement.

It is up to the user to determine if it is appropriate to deviate from the minimum recommended specimen dimensions.

When the cooling phase data will be included in the final analysis the minimum required specimen size is larger relative to the minimum required specimen size if only the

heating phase is used. It takes longer to record the cooling phase data, therefore the heat diffuses over a larger distance and the specimen size needs to be sufficient. Since the measurement takes twice as long, the minimum specimen diameter increases by a factor $\sqrt{2}$ (~ 1.41).

To measure the thermal conductivity of a specimen, insert the entire needle into the specimen. For soft penetrable materials and fine granular materials the needle can be inserted directly, for hard specimen such as rocks it may be necessary to drill a hole prior to inserting the needle. When predrilling a hole, the diameter should be just large enough to encompass the needle. Thermal contact between the specimen and the probe can be improved by filling the hole with the drilling residue or with a thermal contact agent such as a thermal paste or glycerol. For semi-hard materials or materials that are being casted special guiding tubes can be used (see Hukseflux GT series). The guiding tubes can be inserted into the material without the risk of damaging the thermal needle probe. The needle can then be inserted into the guiding tube. A set of 5 guiding tubes is included with your TPSYS20 delivery.

Make sure that the probe is mechanically stable and cannot move during the measurement. If necessary, fix the probe using a lab stand.

NOTICE

Make sure that the probe is inserted into the specimen in a mechanically stable manner. Movement of the probe during a measurement may make the measurement result inaccurate or invalid.



CAUTION

Prevent puncture wounds. Although the thermal needle probes are not very sharp, it is recommended to keep the needle away from eyes and to place the cover on the thermal needle probe when it is not in use.

5.3.2 Performing a measurement

To measure the thermal conductivity of a specimen, follow the steps below:

1. Insert the thermal needle probe into the specimen as described in Section 5.3.1. Make sure that the thermal needle probe is mechanically stable and cannot move during the measurement. Furthermore, minimize thermal contact resistance between the needle and the specimen.
2. Open the web interface and select the **Measurements** tab.
3. In the **Measurements** tab, in the **Measurement parameters** box set the following parameters:
 - **Specimen description** – enter a description by which the specimen can be identified.
 - **Waiting time** – it is recommended to use a waiting time of at least 60 s. The default value is 120 s.

- **Heating time** – typical heating times are between 20 and 180 s. Specimen with a lower thermal conductivity require a larger heating time. The default value is 120 s.
 - **Use cooling data** – Using cooling data makes the measurement less sensitive to specimen temperature drift and therefore more accurate, but also increases the total measurement time, thus making the measurement process more time consuming.
 - **Heater power** – the heater power can be set between 0.01 W/m and 5.0 W/m. Specimen with a higher thermal conductivity require a higher heater power. The default value is 1.0 W/m.
4. To start a measurement:
- Preferably* click the **Start when stable** button in the **Controls** box. The system will assess the stability of the **temperature difference** signal. While the system is assessing the stability the **Stabilizing** indicator in the **Measurement progress** box will light up and the green measurement running LED on the MCU will blink. Once the temperature difference signal meets the stability criterion the system will automatically start a measurement.
- Alternatively* wait for the **temperature difference** signal to become sufficiently stable. As a starting point the temperature drift should be within 10 mK/min. Once the temperature difference signal is stable click the **Start measurement** button in the **Controls** box.
- While a measurement is running the **Measurement running** indicator in the **Measurement progress** box will light up and the green measurement running LED on the MCU will be on continuously. The measurement can be cancelled at any time by clicking the **Stop** button in the **Controls** box.
5. Allow the measurement to complete. Measurement progress can be monitored via the **Measurement progress** box in the **Measurements** tab. While a measurement is running the **Measurement running** indicator in the **Measurement progress** box will light up and the green measurement running LED on the MCU will be on continuously. When the heater is on the **Heater on** indicator in the **Measurement progress** box will light up and the red heater on LED on the MCU will be on. Live data, such as temperature and heater power, can be seen in the graphs at the bottom of the **Measurements** tab.
6. When the measurement has finished the results can be viewed in the **Summary of results** box in the **Measurements** tab and in more detail under the **Results** tab (see Section 5.3.3).

Measurement parameters

Next experiment id:	3
Specimen description:	<input type="text"/>
Waiting time:	<input type="text" value="100,0 s"/>
Heating time:	<input type="text" value="250,0 s"/>
Use cooling data:	<input type="button" value="Yes"/>
Total measurement time:	600,0 s
Heater power:	<input type="text" value="5,00 W/m"/>

Figure 5.3.2.1 The measurement parameters box under the measurements tab

NOTICE

Make sure that the temperature difference is stable before starting a measurement. Starting a measurement before the temperature difference is stable, can lead to inaccurate or invalid results.

5.3.3 Viewing measurement results

Detailed measurement results can be found in the **Results** box under the **Results** tab.

The **Results** tab also contains the **Measurement quality checks** box. When a measurement quality check shows a red cross, this means that something may be amiss with the measurement. The box contains the following measurement quality checks (see Figure 5.3.3.1):

- **Heater resistance value entered by user** - if this measurement quality check fails an incorrect or unrealistic heater resistance value has been entered for the heater resistance in the **thermal needle probe** box on the **measurement settings** tab. The measurement will be aborted. Refer to Section 5.1.
- **Heating time set by user in allowable range** - if this measurement quality check fails the user has set the **heating time** in the **measurement parameters box** on the **measurements** tab to a value that is beyond the capabilities of the system because it was either too short or too long. The system has adjusted the **heating time** to the nearest acceptable value and will continue the measurement. Note that this check does not guarantee that the heating time set by the user is appropriate for the specimen.
- **Heater power set by user in allowable range** - if this measurement quality check failed the user has the **heater power** in the **measurement parameters box** on the **measurements** tab to a level that the system is not capable of (it was either too high or too low). The system will adjust the heater power to the nearest acceptable level and continue the measurement. Note that this check does not guarantee that the heater power set by the user is appropriate for the specimen.
- **Heater power sufficient.** - If this indicates a fail the temperature increase during the heating phase is too small. The signal-to-noise ratio may be low,

because of a low signal. If possible, increase the heater power and repeat the measurement.

- **Heater power stability.** – If this check fails the heater power was unstable. Check if all connectors are connected properly. Repeat the measurement.
- **Temperature stability before heating.** – If this quality check fails the temperature difference ΔT just prior to heating was unstable. The measurement accuracy may be affected by specimen temperature drift. Allow the probe and specimen more time to reach a thermal equilibrium before starting a measurement. Perform the measurement in a thermally stable environment. Heating, air conditioning, open windows, sunlight, etc. may affect temperature stability.
- **Temperature monotonically increasing during heating.** - If this measurement quality check fails the temperature difference was not monotonically increasing during the heating phase. This may indicate mechanical instability, temperature instability or in case of fluids convection. Make sure that the probe does not move during the measurement and that the specimen temperature is stable before starting a measurement. In case of fluids, if convection is suspected reduce the heater power.
- **Temperature monotonically decreasing during cooling.** - If this measurement quality check fails the temperature difference was not monotonically decreasing during the cooling phase. This may indicate mechanical or temperature instability. Make sure that the probe does not move during the measurement and that the specimen temperature is stable before starting a measurement.
- **Consistent thermal conductivity heating/cooling phase.** - If this check fails there is large difference between the thermal conductivity determined from heating phase data and the thermal conductivity from cooling phase data. This may indicate mechanical instability, temperature instability or in case of fluids convection. Make sure that the probe does not move during the measurement and that the specimen temperature is stable before starting a measurement. In case of fluids, if convection is suspected reduce the heater power.
- **Thermal conductivity in measurement range.** This check fails if the thermal conductivity falls outside thermal conductivity measuring range of the system (see specifications in Chapter 3).

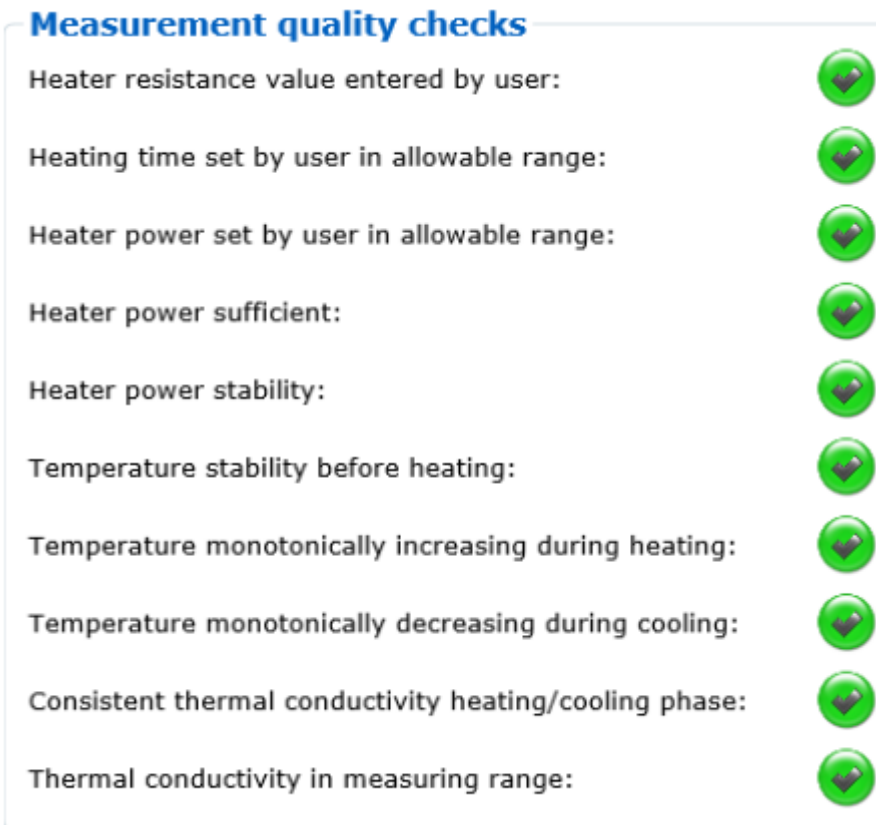

Figure 5.3.3.1 *The measurement quality checks box in the results tab*

The results displayed by the MCU should be considered preliminary results. Hukseflux strongly recommends downloading the raw data (see Section 5.4) and using the data analysis tool (see Chapter 6) to analyse the data and determine the final results.

5.4 Retrieving measurement data

An overview of the results from all experiments can be downloaded by clicking the **download results** button in the **Results** box on the **Results** tab. See Table 5.4.1. for a description of the file content.

Table 5.4.1 *Overview of the columns in the result file (continued on next pages)*

RESULTS TABLE	
Column name	Description
TIMESTAMP	a timestamp for the measurement, ISO 8601 format, YYYY-MM-DD hh:mm:ss.s
RECORD	a record number for each entry in the table
experiment_id	a number used to identify the experiment
type	"Measurement" or "Calibration"
specimen_description	a description of the specimen as specified by the operator
Cal_OK	"Yes" or "No" if this was a calibration measurement "N/A" if this was a regular measurement

thermal_conductivity	the measured thermal conductivity in W/(m·K), an indicative result
thermal_conductivity_sd	the standard deviation of the measured thermal conductivity in W/(m·K)
P_heat_avg	the average heater power during the heating phase in W/m
P_heat_std	the standard deviation of the heater power during the heating phase in W/m
stabilization_time	if the Start when stable button was used, the time it took for the specimen to become thermally stable enough
waiting_time	the time interval during which data was recorded prior to heating. This data is used to determine the temperature stability.
heating_time	The duration of the heating phase. If cooling data was measured, then this is also the duration of the measurement in the cooling phase.
measure_cooling_data	0 if no, -1 if yes
tc_heating	the thermal conductivity determined from the heating phase in W/(m·K)
tc_sd_heating	the standard deviation of the thermal conductivity determined from the heating phase in W/(m·K)
tc_cooling	the thermal conductivity determined from the cooling phase in W/(m·K), an indicative result
tc_sd_cooling	the standard deviation of the thermal conductivity of the cooling phase in W/(m·K)
probe_model	the model of the thermal needle probe, e.g. TP02 or TP08
probe_serial_number	the serial number of the thermal needle probe
heater_resistance	the heater resistance in Ω/m
R_Re	warning indicating that an invalid or unrealistic value was entered for the heater resistance
R_Heat_time	warning indicating that the heating time set by the user was either too long or too short and that the system has adjusted the heating time to the nearest acceptable value
R_heater_power	warning indicating that the heater power set by the user was beyond the capabilities of the system and that the system has adjusted the heater power to nearest acceptable level
R_P_low	warning indicating that the heater power may have been too low
R_P_stability	warning indicating that the heater power was unstable during the heating phase
R_T_stability	warning indicating that the temperature was unstable just prior to the heating phase
R_sig_stability_heating	warning indicating that the temperature was not monotonically increasing during the heating phase
R_sig_stability_cooling	warning indicating that the temperature was not monotonically decreasing during the cooling phase
R_lambda_heating_cooling	warning indicating that the thermal conductivity measured in the cooling phase differs by more than 5 % from the thermal conductivity measured in the

	heating phase, i.e. the measurements are inconsistent.
R_lambda	warning indicating that the thermal conductivity is outside the thermal conductivity measuring range of TPSYS20
experiment_aborted	0 if measurement was completed, -1 if measurement was aborted by the user
power_supply_voltage	the power supply voltage, useful when the system is battery operated
Raw_data_filename	file name of the corresponding raw data file

The raw data from the last measurement can be downloaded by clicking the **Download raw data** button in the **Results** box on the **Results** tab.

The results from previous measurements can be viewed by clicking the **browse records** button in the **Results** box on the **Results** tab. This will open the record browser. The record browser allows the user to view previous results. Navigate previous results using the **previous** and **next** button or select a measurement from the drop down menu (see Figure 5.4.1). To download raw data from a previous measurements, click the **download raw data** button in the record browser. See Table 5.4.2 for a description of the file content.

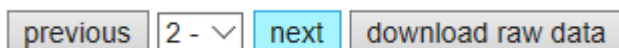

Figure 5.4.1 Record browser controls

Table 5.4.2 Description of the columns in the raw data file

RAW DATA TABLE	
Column name	Description
TIMESTAMP	a timestamp for the measurement
RECORD	a record number used to identify a specific measurement
experiment_id	a number used to identify the experiment
heater_resistance	the heater resistance in Ω/m
time	the time since the start of heating in s
heater_current	the electrical heater current in A
temperature_difference	the temperature difference in K
U_sen	the raw thermocouple voltage in mV
Pt_1000	the temperature of the Pt1000 thermometer in the base of the probe
T_hot	the temperature of the hot joint of the thermocouple in $^{\circ}C$, located halfway through the heated section of the needle
T_cold	the temperature of the cold reference joint in $^{\circ}C$ (TP02 only)
sensitivity	the sensitivity of the thermocouple in $\mu V/K$

6 Data analysis

As a first step in the analysis of measurement data, the TPSYS20 MCU automatically performs a simplified data analysis at the end of each measurement cycle. A second, more accurate and more detailed data analysis is performed by the user using the TPSYS20 data analysis tool which is included in each TPSYS20 measuring system delivery. This post-processing tool helps to execute the data analysis procedures as outlined in Section 2.3 and provides a few simple quality assurance indicators. Section 5.4 explains how to retrieve the measurement data ready for analysis after a measurement has been executed. Chapter 6 is a practical guide to use the data analysis tool to perform further data analysis.

The measurement results produced by the TPSYS20 MCU should be considered preliminary. Hukseflux strongly recommends using the data analysis tool to attain the final result. In some cases the measurement result produced by the TPSYS20 MCU may be used directly, but extreme care should be taken when doing so. It is essential to strictly control the measurement conditions and the data analysis conditions and to keep them within a small, predetermined range. The specimens should also be consistent in size and thermal properties. In general cases, the thermal conductivity values produced by the measuring system can only be taken as indicative values and no claims regarding accuracy, etc. can be made based on these.

NOTICE

Measurement results provided by the measuring system can in general only be used as indicative results and no claims about measurement accuracy can be based on these results.

6.1 The tool

Downloading data from the measurement system results in a data file with a file name similar to "CRD_RawData_102.dat". Section 6.4 explains the contents of this data file and the meaning of the column headings. The data analysis tool is designed in such a way that inserting these data is easy.

The tool can be opened using Microsoft Excel or a compatible alternative. The procedures explained here assume Microsoft Excel as part of Microsoft Office 365. Other compatible alternatives may be used, and the general procedures still apply, but these versions may look different and details of the procedure to follow may deviate.

After the opening the data analysis tool using MS Excel and importing and selecting a valid data set it looks similar to Figure 6.1.1. Four tabs are visible:

manual

shows a typical example of the results tab and provides a brief explanation of the usage of this tool. The tab may be used as a quick-start guide, but does not replace this user manual;

results

is presenting the measured data, presents the results of the data analysis and provides some user input for the analysis;

raw data

contains the raw measurement data as downloaded from the measurement system;

charts only

is for auxiliary use and enables the user to export the graphs without the risk of unintentionally modifying the graphs on the "results" tab

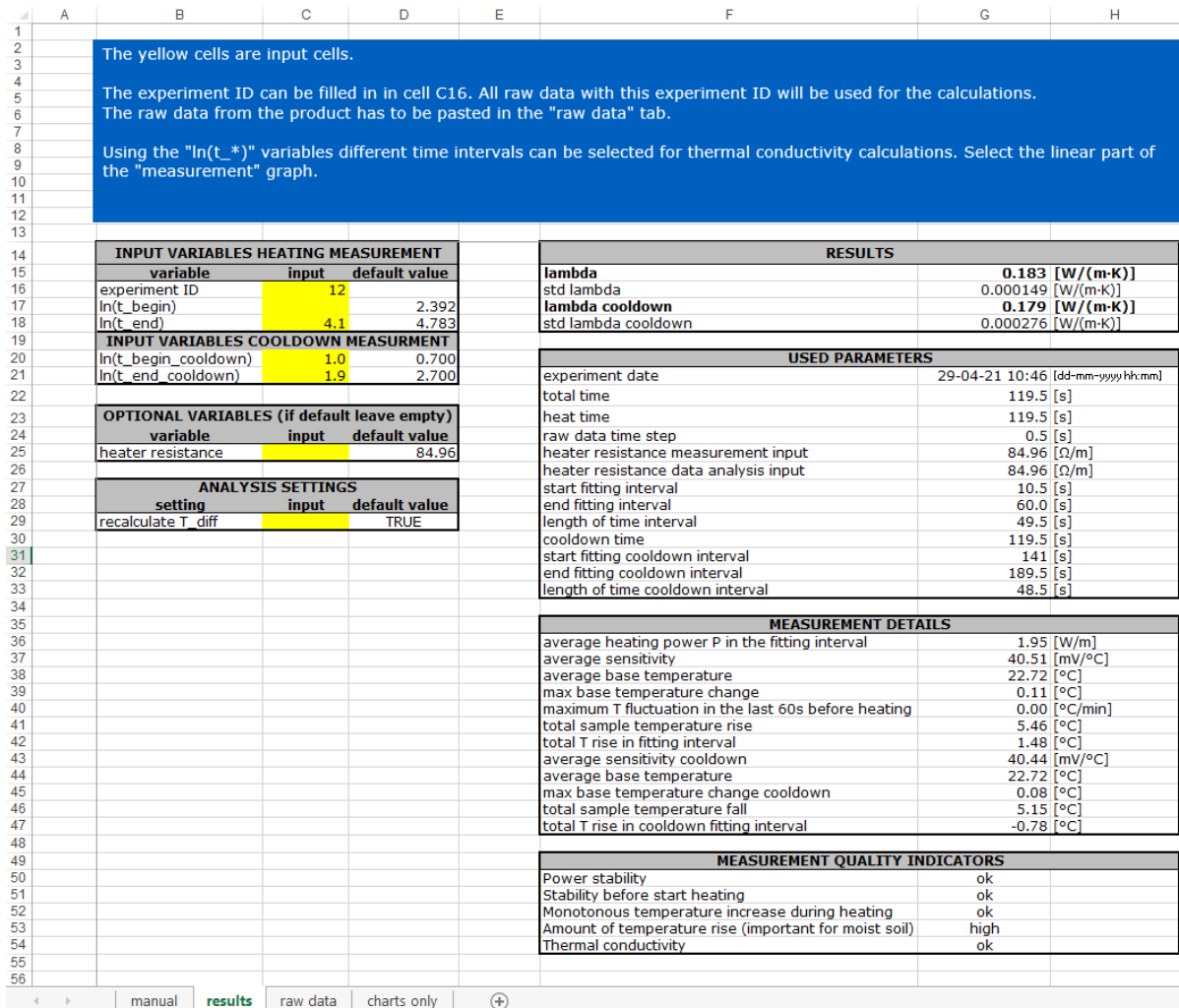

Figure 6.1.1 The data analysis tool after it has been opened and a valid data set was imported and selected

The main place for user input and output is the "results" tab. But before the actual analysis can be started, measurement data needs to be provided as explained in the next section.

6.2 Data import

After opening the data analysis tool take the following steps to import the raw measurement data:

1. Use MS Excel to import the raw data file by selecting "Open" from the "File" menu. Select "Browse" at the left and located the downloaded raw data file with filename similar to "CRD_RawData_102.dat." If the file is not visible in the expected location, ensure that the "All files (*.*)" is selected so that data files with the ".dat" file extension are displayed.
2. Select the data file containing the data to be analysed and select "Open". A screen similar to Figure 6.2.1 is displayed. Ensure that "Delimited" is selected and select the "Next >" button.
3. Select the box in front of "Comma" and verify that the columns are shown separated as at the left side of Figure 6.2.1 and select the "Finish" button.
4. This opens the data file similar to Figure 6.2.1.

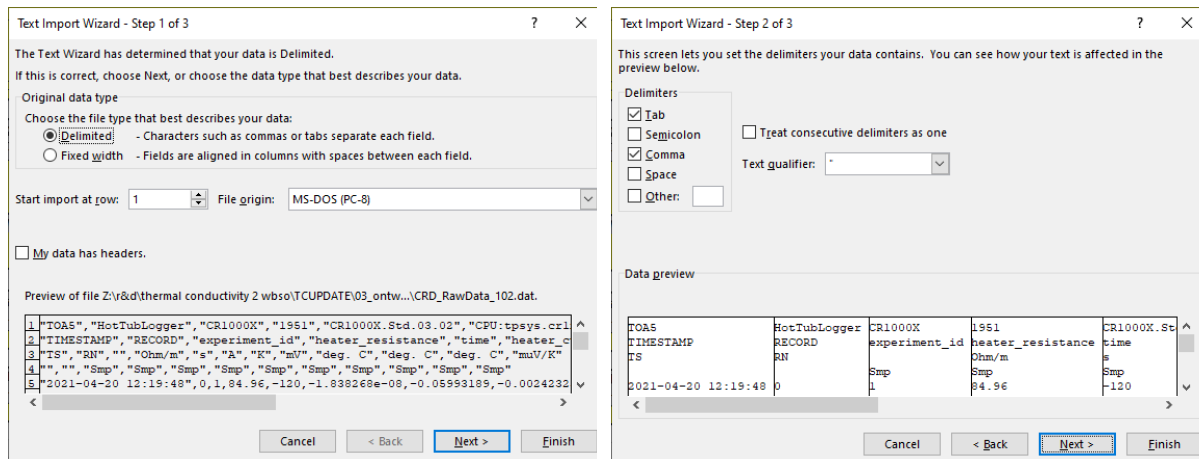

Figure 6.2.1 The first two screens of the MS Excel import wizard

To avoid accidentally overwriting the original tool sheet or the result of a previous analysis, ensure to save the sheet with a name different from the original. Copies of the tool can be kept retaining the data for later use or for archiving purposes.

	A	B	C	D	E	F	G	H	I	J	K	L
1	TOA5	HotTubLo	CR1000X	1951	CR1000X.S	CPU:tpsys	32711	RawData				
2	TIMESTAM	RECORD	experime	heater_re	time	heater_cu	temperatu	U_sen	Pt_1000	T_hot	T_cold	sensitivity
3	TS	RN		Ohm/m	s	A	K	mV	deg. C	deg. C	deg. C	muV/K
4			Smp	Smp	Smp	Smp	Smp	Smp	Smp	Smp	Smp	Smp
5	#####	0	1	84.96	-120	-1.84E-08	-0.05993	-0.00242	23.33467	22.67461	22.75548	40.43307
6	19:48.5	1	1	84.96	-119.5	2.07E-08	-0.06307	-0.00255	23.33528	22.67529	22.7564	40.43314
7	#####	2	1	84.96	-119	7.38E-08	-0.05942	-0.0024	23.33548	22.6751	22.75618	40.43344
8	19:49.5	3	1	84.96	-118.5	2.46E-07	-0.0601	-0.00243	23.33487	22.67636	22.75639	40.43425
9	#####	4	1	84.96	-118	-4.82E-08	-0.05946	-0.0024	23.33507	22.67821	22.75674	40.43412
10	19:50.5	5	1	84.96	-117.5	3.37E-08	-0.06007	-0.00243	23.33487	22.67636	22.75649	40.43295
11	#####	6	1	84.96	-117	9.61E-10	-0.06117	-0.00247	23.33507	22.67741	22.75538	40.43335
12	19:51.5	7	1	84.96	-116.5	-2.90E-07	-0.05931	-0.0024	23.33507	22.67911	22.7549	40.43271

Figure 6.2.2 An example of a raw data file after importing the data into MS Excel

To finalise the import process:

1. Select all data by clicking the triangle in the upper right corner of the sheet or by pressing the "Ctrl" and "a" keys simultaneously.
2. Copy the data by pressing "Ctrl" and "c" keys simultaneously.
3. Go to the saved copy data analysis sheet to be used and select the "raw data" tab shown at the bottom.
4. To ensure any existing data is overwritten and the end result is a sheet with only the raw data from the imported data file, repeat step 1. Now press the "Ctrl" and "v" keys simultaneously to copy the data into the sheet. Remove any remains of the existing data.
5. Verify that the data looks similar to Figure 6.2.2 and that the tab contains the desired data set. Select the "results" tab at the bottom and save the file before continuing.

6.3 Analysis process

The analysis process using the data analysis tool aims to select the parts of the data where the temperature as a function of the logarithm of the measurement time increases linearly (in a straight line). This is the region in which the model as explained in Chapter 2 is valid. Building up experience with this type of data analysis while using the tool and with things that can go wrong during the measurement helps identify any problems with the data and is important for the quality of the analysis. It is strongly recommended that the person using the analysis tool also knows how to perform a measurement.

NOTICE

It is strongly recommended that the person using the analysis tool also knows how to perform a measurement and has a basic understanding of the used model explained in this manual.

Before starting the actual analysis, the desired data set needs to be selected by inputting the experiment ID as generated during the experiment in the yellow cell in the "input" column behind the "experiment ID" label.

NOTICE

The Excel file of the data analysis tool contains hidden and locked cells and tabs. Attempts to edit or unlock these features may result in unexpected behaviour of the tool and unexpected output. Only the yellow cells can be edited for this reason.

When a valid experiment ID is selected the "results" tabs looks similar to Figure 6.3.1.

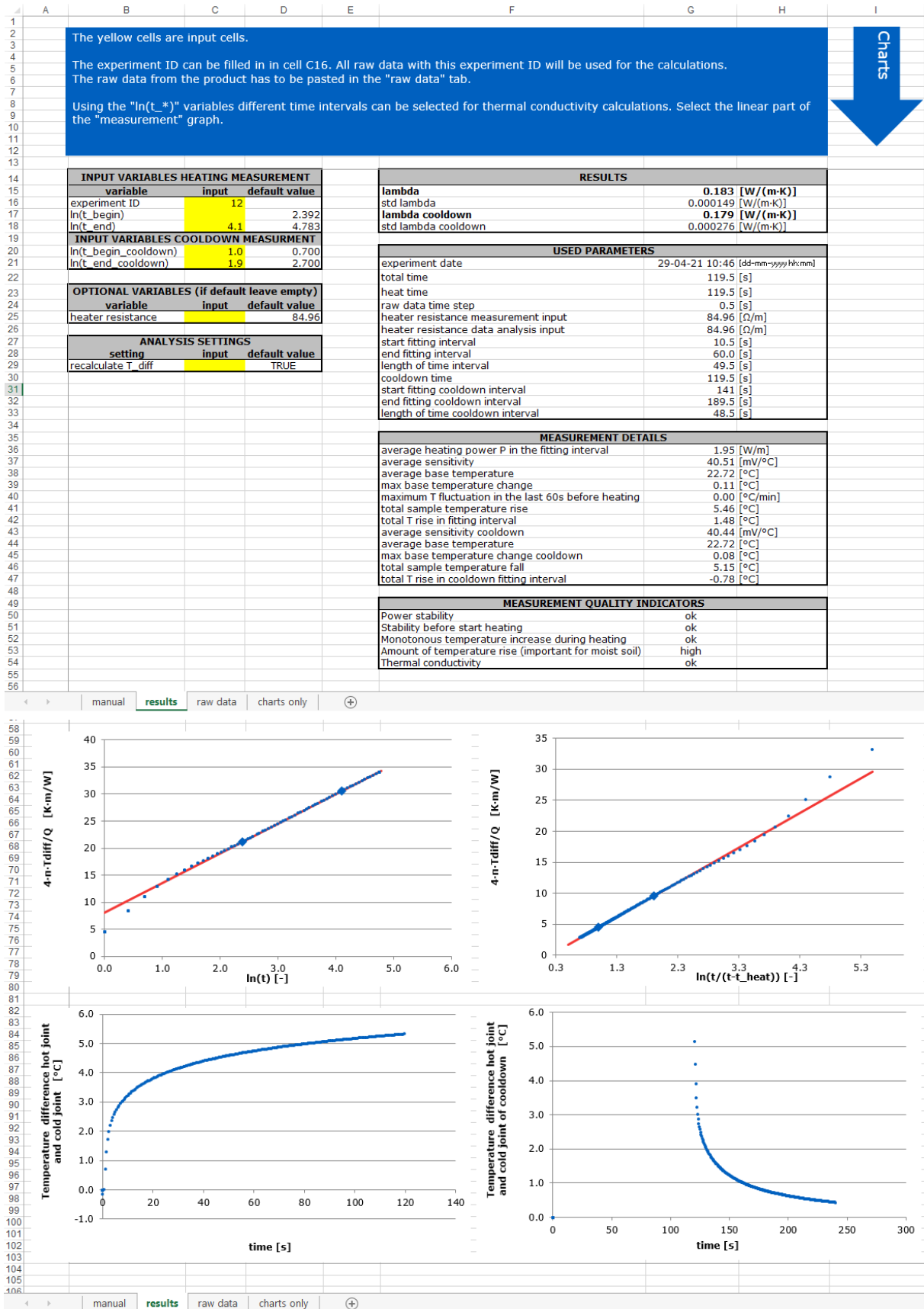

Figure 6.3.1 Data analysis after selecting a valid experiment ID

The essence of the data analysis is that the data is visually inspected using the graphs (seen if scrolled down) and the numerical data on top. Due to auxiliary effects, such as heating of the needle itself, evaporation or convection of fluids or signatures of a finite specimen size, the data analysis interval needs to be selected in such a way that the model as explained in Chapter 2 is valid. Valid data will follow a straight, increasing trend moving from left to right. To enhance the accuracy of the analysis data, the heating phase can be combined with the cooling phase. A condition is that the specimen size is not limiting the data analysis over the whole period of time and that it is at least equal to the value mentioned in Chapter 5.3.1 on minimum recommended specimen dimensions.

Start and end point for the analysis in the heat phase is chosen by inserting them in the yellow cells in the input column behind:

- $\ln(t_begin)$
- $\ln(t_end)$

and in a similar way for the cooling phase:

- $\ln(x_lowerbound)$
- $\ln(x_upperbound)$

Select a start point and end point in the heating phase by inspecting the top-left graph and the top-right graph to select these points for the cooling phase.

To correct any deviations from the heater resistance programmed into the measurement system, it is possible to provide an alternative value. Extreme care should be taken here and only factory calibration data should be used, because the heater value is critical to the analysis yielding correct results.

If "recalculate T_diff " is set to TRUE the excel sheet to recalculate T_diff from U_sen . If set to FALSE the excel sheet uses the T_diff values calculated by the TPSYS20 MCU. The default value is FALSE. The user does not normally have to set this parameter.

NOTICE

Only use heater resistance values provided by the factory for the used needle probe when using the option to provide an alternative value.

6.3.1 Data selection hints

Since the model is always an approximation of what happens in reality, the data points are expected to deviate from a straight line due to for example:

- measurement noise due to external disturbances
- non-ideal measurement conditions such as drifting specimen temperature, evaporation of moisture from the specimen, convection in fluid specimens, etc.
- insufficient time between measurements

Slight deviations are therefore allowable. Part of the purpose of the data selection procedure is to analyse the extent to which these unwanted effects play a role in the end result, and to eliminate them by selecting an appropriate data interval. But for the analysis to yield reliable results the $\ln(t)$ data interval (between the dots) should not be chosen shorter than 1.00 as general rule of thumb.

Some hints to help the selection of data:

- Do not put the starting point on the left-most data point because the needle itself is still heating up making the temperature measurement inaccurate here.
- If the data has no straight sections this may be due to drift or evaporation of moisture, depending in the severity of these effects the measurement may have to be redone, taking extra care of the measurement conditions, such as thermal stability, heating power, etc.
- When measuring in fluid, the data points start to follow a horizontal line when convection (a temperature-forced flow) takes place, do not use these portions of data.

Inspecting the “Measurement quality indicators” section may help to assure the data quality is sufficient to yield a reliable outcome of the data analysis.

6.3.2 Cooling phase data

In a similar way the data analysis interval from the cooling phase is selected. In addition to the hints and procedures already mentioned, there are some further recommendations when using the data from the cooling phase.

As a general rule the data of the cooling phase can be regarded as invalid if the heating phase end point t_{end} cannot not be chosen to be last point in the graph at the top left. A recommendation for the minimum specimen dimensions in this case is given in Section 5.3.1.

Based on the selection of $\ln(t_{begin})$ for the heating phase, the data analysis tool will propose an upperbound for $\ln(x)$, namely $\ln(x_{upperbound})$ for the cooling phase. It is possible, but not recommended to manually enter a value for $\ln(x_{upperbound})$ as $\ln(t_{begin})$ and $\ln(x_{upperbound})$ are expected to be correlated.

Note that in the top right graph, $\ln(x) = \ln(t/(t-t_{heat}))$ decreases for increasing time.

NOTICE

Only use data from the cooling phase for analysis if the data of the heating phase is valid up to the last data point of the heating phase.

6.4 Analysis results

The results of the analysis are all conveniently show on the “results” tab. Analysis results include the determined thermal conductivity, but also information about the

measurement conditions and some data quality indicators. This information is divided in several section. Below a brief explanation of each section is provided.

6.4.1 Results table

The "results" section shows the determined thermal conductivity of the heating phase and also of the cooling phase if available. Besides the thermal conductivity it also shows the statistical variation of the data with respect to the determined value: the standard deviation. Parameters labels, etc. from the tool file are not explained in detail here, because they should be self-explanatory after reading this manual.

6.4.2 Used parameters

A list of the parameters used during the data analysis but also properties of the data set is listed in the "used parameters" section, such as the data sampling interval and the start time and data of the data set.

6.4.3 Measurement details

An overview of the measurement conditions and some statistical derived data is listed in the "measurement details" section.

6.4.4 Measurement quality indicators

The "Measurement Quality Indicators" table contains some quality indicators that may help to validate the data. Except for the "Amount of temperature rise" indicator, which should preferably show "Medium", all other indicators should show "ok", if they do not special attention should be taken.

Power stability

Indicates if the measured heater power was stable enough during the measurement. The heater power is considered to be "unstable" for values $> \pm 0.01$ W/m.

Stability before start heating

Indicates if the temperature of the needle and the specimen are sufficiently stable before the heating phase is started. This is important as it generates a 'background' effect which cause measurement results to be inaccurate. The stability before start heating is considered to be "unstable" for values $> \pm 0.05$ K.

Monotonous temperature increase during heating

Indicates if the temperature keeps increasing during the heating phase as time progresses. If this is not the case the data cannot be used to produce accurate results.

Amount of temperature rise (important for moist soil)

Indicates if the amount of temperature rise during the heating interval is "Low", "Medium" or "High". The amount of temperature should preferably be "Medium". "Low" may mean that the signal is too low. "High" may mean that evaporation can affect the measurement if moist specimen are being measured.

Low: $T < 0.25$ °C

Medium: $0.25 \leq T \leq 2.5$ °C

High: $T > 2.5$ °C

Thermal conductivity

Indicates if the measured thermal conductivity is within the rated measuring range of the TPSYS20 system.

Too low: $\lambda < 0.1 \text{ W/(m}\cdot\text{K)}$

OK: $0.1 \leq \lambda \leq 6 \text{ W/(m}\cdot\text{K)}$

Too high: $\lambda > 6 \text{ W/(m}\cdot\text{K)}$

7 Maintenance and trouble shooting

7.1 Recommended maintenance and quality assurance

TPSYS20 measures reliably at a low level of maintenance. Unreliable measurement results are detected by scientific judgement, for example by looking for unreasonably large or small measured values. The preferred way to obtain a reliable measurement is a regular critical review of the measured data, preferably checking against other measurements.

Table 7.1.1 *Recommended maintenance of TPSYS20*

MINIMUM RECOMMENDED TPSYS20 MAINTENANCE			
	INTERVAL	SUBJECT	ACTION
1	every experiment	data analysis	Critically review the raw data. Look for any patterns and events that deviate from what is normal or expected.
2	every time a thermal needle probe is connected to the MCU	Programming the thermal needle probe parameters	Set the thermal needle probe parameters in the MCU's web interface to match the parameters on the thermal needle probe's product certificate.
3	every measurement campaign	calibration	When changing the thermal needle probe, moving TPSYS20 to a different measuring location, or when starting a new measurement campaign, calibrate the system.
4	3 years	internal battery replacement	The internal lithium battery in the MCU is rated for a 3 year life with no external power source. If the battery is exhausted, contact Hukseflux Thermal Sensors B.V. for options for battery replacement.
5	2 years	recalibration	Recalibration by manufacturer

7.2 Trouble shooting

Table 7.2.1 *Trouble shooting for TPSYS20 (continued on next page)*

<p>The measurement does not start when using the start-when-stable function</p>	<p>The start-when-stable function assesses the stability of the temperature difference signal. Once the temperature difference signal meets the stability criterion the MCU will automatically start a measurement. In some cases the stability criterion will never be met and the measurement will not start. This can be the case if the temperature of the environment in which the measurements are performed fluctuates too much. In that case the measurement should be performed in a thermally more stable environment if possible. Avoid exposing the specimen and thermal needle to direct sunlight, air flows from open windows and doors, air conditioning and heating. If necessary, use a less strict temperature stability criterion (at the expense of measurement accuracy). The temperature stability criterion can be set in the TPSYS20 web interface on the Measurement settings tab in Temperature stability assessment box.</p>
<p>The thermocouple signal is erratic or unrealistically high or low.</p>	<p>Check if the connector of the thermal needle probe is properly connected to the MCU.</p> <p>If this does not resolve the problem use a multimeter to check the thermocouple for broken wires (see Appendix 8.7 for wiring). If the thermocouple is broken contact Hukseflux Thermal Sensors B.V. to discuss repair or replacement options.</p>
<p>The heater does not switch on.</p>	<p>Make sure that the power supply unit (PSU) is connected to the MCU and plugged into mains. Make sure that the MCU is switched on. Check if the Power ON LED on the MCU is on. Check if the Power supply voltage shown in the MCU status box on the MCU settings tab is within the rated operating voltage of the MCU as specified in Chapter 3. If the voltage is ok, try starting a measurement. If the voltage is too low the PSU may be defective. In that case contact Hukseflux Thermal Sensors.</p> <p>If the PSU is ok and the problem persists, disconnect the thermal needle probe from the MCU and use a multimeter to measure the heater resistance of the thermal needle probe (see Section 8.7). Check if the heater value is within $\pm 3 \Omega$ of the nominal values specified in Chapter 3 for the given thermal needle probe. NOTE: the nominal heater resistance depends on the thermal needle probe model. If the heater wire is broken (resistance too high) or if the heater wire is short circuited (resistance too low) <i>either</i> contact Hukseflux Thermal Sensors B.V. to discuss repairs or replacement options for the thermal needle probe <i>or</i> connect a spare thermal needle probe if you have one available.</p> <p>If the heater wire of the thermal needle probe is ok and the problem persists the MCU may be defective. In that case contact Hukseflux Thermal Sensors B.V. to discuss MCU repair options.</p>
<p>The TPSYS20 web interface does not respond.</p>	<p>Make sure that the thermal needle probe is connected. Check the USB or ethernet connection. Refresh the webpage.</p> <p>If this does not resolve the problem switch off the MCU, disconnect the power supply from mains and disconnect the USB and ethernet connections from the MCU. After 1 minute. Reconnect and restart the MCU.</p>

The measured thermal conductivity is incorrect.	Review the Measurement quality checks box on the Results tab of the web interface. Refer to Chapter 5 for more details about the meaning of the measurement quality checks and appropriate action if one of the checks fails. Check if the thermal needle probe's heater resistance has been correctly programmed into the MCU. The heater resistance value set in the Thermal needle probe box on the Measurement settings tab should match the value on the product certificate. Make sure the specimen thermal conductivity falls in the measuring range of TPSYS20 (see Chapter 3). If the specimen thermal conductivity falls outside this range TPSYS20 is not suitable for measuring the thermal conductivity of this specimen. When measuring liquids, the thermal conductivity measurement may be affected by convection. When convection is suspected reduce the heater power. Only viscous liquids such as glycerol can be measured with TPSYS20. TPSYS20 is not suitable for measuring non-viscous liquids such as water. Make sure the thermal needle probe is mechanically stable during the experiment. Movement of the probe renders the measurement invalid. Movement can typically be recognized by a non-monotonic temperature difference signal with sudden drops in signal. Make sure the sample size is sufficient. Refer to Chapter 3 and 5 for recommended specimen dimensions. During the heating and cooling phase heat generated by the thermal needle probe diffuses through the specimen material. When the heat diffuses to the boundaries of the specimen, the measurement will be affected by environmental factors.
---	--

The time stamps in the "Results" and "RawData" tables are incorrect.	The TPSYS20 MCU clock needs to be set. See Section 4.3 for instructions. If this is a recurring problem without clear cause the internal battery may have to be replaced.
--	---

8 Appendices

8.1 Theory

8.1.1 Measurement function

A thermal needle probe can in first approximation be modelled as an infinitely long linear heat source with zero heat capacity located inside a specimen with infinite diameter. In that case the temperature during the heating phase at time t at a distance r from the centre of the needle is given by:

$$\Delta T = -\frac{Q}{4\pi\lambda} \text{Ei} \left(-\frac{r^2}{4\alpha t} \right) \quad \text{for } 0 < t \leq t_{\text{heat}}$$

where Ei denotes the exponential integral, λ is the thermal conductivity of the specimen, α is the thermal diffusivity of the specimen (in m^2/s), Q is the heater power (in W/m). Similarly, during the cooling phase:

$$\Delta T = -\frac{Q}{4\pi\lambda} \left[\text{Ei} \left(-\frac{r^2}{4\alpha t} \right) - \text{Ei} \left(-\frac{r^2}{4\alpha(t - t_{\text{heat}})} \right) \right] \quad \text{for } t > t_{\text{heat}}$$

For sufficiently large times (see Section 8.1.3 for more details), at a fixed location, the models can be written using a Puiseux series expansion. For the heating phase the model simplifies to:

$$T \approx \frac{Q}{4\pi\lambda} \ln(t) + \text{constant} \quad \text{for } 0 < t_1 < t \leq t_{\text{heat}}$$

and for the cooling phase:

$$T \approx \frac{Q}{4\pi\lambda} \ln \left(\frac{t}{t - t_{\text{heat}}} \right) \quad \text{for } t > t_{\text{heat}} + t_1$$

Above models show that for sufficiently large times the slope of the temperature-versus-logarithm-of-time curve for the heating phase and the slope of the temperature-versus- $\ln[t/(t-t_{\text{heat}})]$ curve for the cooling phase depend on the thermal conductivity λ and heater power Q only.

TPSYS20 measures the temperature difference between the thermocouple hot junction located halfway through the heated section and *either* the thermocouple cold junction located in the tip of the needle (TP02) *or* the thermocouple reference junction in the base of the thermal needle probe (TP08). TP02 and TP08 use type K thermocouples. The thermocouple voltage is measured by the CR1000X datalogger. The sensitivity of type K thermocouples can be deduced from the thermoelectric voltage functions found on the NIST website: https://srdata.nist.gov/its90/type_k/kcoefficients.html.

TPSYS20 measures the heater current I by measuring the voltage U_{shunt} over a 5.000Ω shunt resistor. Using the heater current I and the known heater resistance per unit length R_L , the heater power Q can be accurately calculated. The heater power per unit length is therefore:

$$Q = R_L \cdot I^2 = R_L \cdot \left(\frac{U_{\text{shunt}}}{R_{\text{shunt}}} \right)^2$$

Details about the calibration of the heater resistance R_L , the shunt resistor R_{shunt} and the voltage measurement U_{shunt} by the CR1000X datalogger can be found on the product certificate.

By evaluating the slope of the temperature-versus-logarithm-of-time curve for the heating phase and the temperature-versus- $\ln[t/(t-t_{\text{heat}})]$ curve for the cooling phase, e.g. by using a linear regression technique, the thermal conductivity can be calculated:

$$\lambda = \frac{Q}{4\pi \times \text{slope}}$$

8.1.2 Thermal resistivity

TPSYS20 is suitable for measuring the thermal resistivity of specimen. The thermal resistivity r is inversely proportional to the thermal conductivity λ :

$$r = \frac{1}{\lambda}$$

It has S.I. units of $\text{m}\cdot\text{K}/\text{W}$. Note that the thermal resistivity contains no additional information: once thermal conductivity is known the thermal resistivity is known and vice versa. The standard uncertainty in the measured thermal resistivity, $u(r)$ in $\text{m}\cdot\text{K}/\text{W}$, can be calculated from the standard uncertainty in the thermal conductivity, $u(\lambda)$ in $\text{W}/(\text{m}\cdot\text{K})$, using the normal rules of error propagation:

$$u(r) = \frac{u(\lambda)}{\lambda^2}$$

Note that the relative uncertainty $u(\lambda)/\lambda$ in the thermal conductivity and the relative uncertainty $u(r)/r$ in thermal diffusivity (in %) are the same:

$$\frac{u(r)}{r} = \frac{u(\lambda)}{\lambda}$$

8.1.3 Transient portion

The initial transient portion of the curve is dominated by effects involving the volumetric heat capacity of the needle and the specimen, the thermal contact resistance between the needle and the specimen and the thermal diffusivity α of the specimen. This transient

portion of the data for time $t < t_1$ should be excluded from the data analysis. To keep errors due to transient effects within 1 %, t_1 should ideally be chosen such that:

$$t_1 \geq 5 \frac{D_{\text{needle}}^2}{\alpha}$$

where D_{needle} is the diameter of the needle.

8.1.4 Edge and end effects

The measurement model assumes infinite specimen diameter and infinite heater length. For sufficiently short times this is an accurate approximation. Towards long times edge effects resulting from the finite specimen diameter D_{specimen} or end effects resulting from the finite heater length L_{heater} start to influence the data. Data affected by edge or end effects should be excluded from the analysis. If only the heating phase is measured this portion of the data can be discarded during a post processing step. If the cooling phase is measured the heat time t_{heat} should be chosen such that edge or end effects only become relevant during the cooling phase. To keep errors due to edge effects within 1 %, t_2 should be chosen such that:

$$t_2 \leq 0.01 \frac{D_{\text{specimen}}^2}{\alpha}$$

Where α is the thermal diffusivity of the specimen material. To keep errors due to end effects within 1 %, t_2 should be such that:

$$t_2 \leq \frac{0.04}{\pi^2} \frac{L_{\text{heater}}^2}{\alpha}$$

Typically the thermal diffusivity α of the material is not exactly known. In that case, to determine t_1 and t_2 either the thermal diffusivity is estimated or t_1 and t_2 are adjusted by trial-and-error until a satisfactory fit is found to the temperature-versus-logarithm-of-time data.

8.2 Uncertainty assessment

The uncertainty assessment should be performed following JCGM 100:2008 *Evaluation of measurement data – Guide to the expression of uncertainty in measurement data*.

The sources of uncertainty can be grouped into several categories: first of all there are uncertainties that arise from the finite accuracy of measuring equipment as well as measurement noise, next there are uncertainties that arise from the finite applicability of the measurement model to the actual measurement and finally there are some errors that result from suboptimal experimental conditions such as specimen temperature drift.

This appendix lists the various contributions to the uncertainty budget. Users must determine the combined standard uncertainty $u_c(\lambda)$ in the thermal conductivity by calculating the root-sum-squared of the individual contributions, while taking into account the sensitivity coefficients $|\partial\lambda/\partial a|$ and coverage factors k of the respective contributions.

8.2.1 Equipment accuracy and noise

Contributions to the uncertainty budget resulting from equipment accuracy and tolerances are listed in Table 8.2.1.1. These contributions can be taken into account by performing a type B uncertainty assessment.

Uncertainty from noise in the temperature difference signal can be taken into account by performing a type A uncertainty assessment. This is most easily done by taking the uncertainty in the slope resulting from the linear fit to temperature-versus-logarithm-of-time curve into account.

Uncertainty from heater power fluctuations can be taken into account by performing a type A uncertainty assessment. The easiest method is to calculate the standard deviation of the measured heater power (in W/m).

For more details about the Campbell Scientific CR1000X datalogger accuracy please refer to <https://www.campbellsci.com/cr1000x>.

Table 8.2.1.1 Accuracy of measuring equipment. The expanded uncertainty is the uncertainty in the corresponding parameter, and must be converted to an uncertainty in the thermal conductivity using the appropriate sensitivity coefficients.

Source	Expanded uncertainty	Coverage factor k
Temperature difference signal		
Type K thermocouple tolerance	0.75 %	1.73
CR1000X voltage readout accuracy	0.04 % of reading + 0.15 μ V	1
Heater power		
Heater resistance	1.00 %	2
Shunt resistor tolerance	0.02 %	1.73
CR1000X voltage readout accuracy	0.04 % of reading + 0.5 μ V	1

8.2.2 Limitations of the measurement model

The measurement model assumes an infinitely long heater in a needle with zero heat capacity and a needle diameter of zero. In reality the heater has a finite length L_{heater} and the needle has a finite heat capacity and diameter D_{needle} . The model provides a valid approximation as long as the criteria outlined in Appendix 8.1.3 and 8.1.4 are met.

8.2.3 Effect of specimen temperature drift

Specimen temperature drift affects the accuracy of the thermal conductivity measurement. Specimen temperature drift can be largely avoided by working in an environment with a stable temperature and by allowing the specimen and thermal needle probe sufficient time to equilibrate. TPSYS20's **Start when stable** function can be used to automatically start a measurement once the specimen temperature drift meets a criterion set by the user. The criterion can be set to < 50 mK/min, < 10 mK/min or < 5 mK/min. The effect of specimen temperature drift is further reduced by including cooling phase data in the analysis. This section discusses a type B estimate for the uncertainty that results from the remaining specimen temperature drift.

If only heating phase data is used in the analysis and it is furthermore assumed that the temperature drift (in K/s) is within $\pm m$ then the expanded uncertainty $U(\lambda)/\lambda$ (in %) resulting from specimen temperature drift is:

$$\frac{U(\lambda)}{\lambda} = \frac{4\pi\lambda}{Q} \frac{t_2 - t_1}{\ln(t_2/t_1)} m$$

With coverage factor $k = 1.73$.

Assuming that the specimen temperature drift during the heating phase and during the cooling phase are correlated in the sense that they have the same sign, including cooling phase data reduces the uncertainty. Assuming data with $t_1 < t < t_{\text{heat}}$ is used for the analysis of the heating phase and data with $t_{\text{heat}} + t_1 < t < 2 \cdot t_{\text{heat}}$ is used for the analysis of the cooling phase, then the standard uncertainty $u(\lambda)/\lambda$ (in %) resulting from specimen temperature drift is:

$$\frac{u(\lambda)}{\lambda} = \frac{2\pi\lambda}{Q} m \sqrt{\frac{a^2}{3} - \frac{2ab}{6} + \frac{b^2}{9}}$$

With a coverage factor $k = 1$ and with a and b given by:

$$a = \frac{t_{\text{heat}} - t_1}{\ln(t_{\text{heat}}/t_1)}$$

$$b = \frac{t_{\text{heat}} - t_1}{\ln[(t_{\text{heat}} + t_1)/(2t_1)]}$$

8.3 Thermal properties of some common materials

Table 8.3.1 lists the thermal conductivity, thermal diffusivity and volumetric heat capacity of some common materials at 25 °C. Table 8.3.2 lists indicative values for the thermal conductivity of some common materials and material types. Table 8.3.3 lists indicative values for the thermal conductivities of soils.

Table 8.3.1 *The thermal conductivity, thermal diffusivity and volumetric heat capacity of some common materials at 25°C*

MATERIAL	THERMAL CONDUCTIVITY	THERMAL DIFFUSIVITY	VOLUMETRIC HEAT CAPACITY	REF.
	[W/(m·K)]	[mm ² /s]	[MJ/(m ³ ·K)]	
Air	0.0026	-	-	[7]
Borosilicate crown glass BK7	1.063	0.552	1.926	[1]
Glycerol	0.285	0.0922	3.09	[3,4]
Polydimethylmethacrylate (PDMS; molecular weights > 14 kDA)	0.16	-	-	[5]
Polymethylmethacrylate (PMMA)	0.1899	0.117	1.614	[1]
Pyrex 7740	1.15	0.650	1.770	[2]
Pyroceram 9606	3.84	2.06	1.868	[2]
Stainless steel AISI 304 L	14.22	3.87	3.676	[2]
Water	0.607	0.145	4.18	[4,6]

- [1.] M.J. Assael, S. Botsios, K. Gialou and I.N. Metaxa; *Thermal Conductivity of Polymethyl Methacrylate (PMMA) and Borosilicate Crown Glass BK7*; Int. J. Thermophys. **26** (2005) p1595-1605
- [2.] M.J. Assael, K. Gialou, K. Kakosimos and I. Metaxa; *Thermal Conductivity of Reference Solid Materials*; Int. J. Thermophys. **25** (2004) p397-408
- [3.] G.W.C. Kaye and W.F. Higgins; *The Thermal Conductivities of Certain Liquids*; Proc. Roy. Soc. A **117** (1928) p.459-470
- [4.] J.A. Balderas-López, Andreas Mandelis and J.A. Garcia; *Measurements of the Thermal Diffusivity of Liquids with a Thermal-Wave Resonator Cavity*; Japan Soc. Analytical Chem. **17** (2001) p519-522
- [5.] O.K. Bates; *Thermal conductivity of Liquid Silicones*; Ind. Eng. Chem. **41** (1949) p1966-1968
- [6.] M.L.V. Ramires, C.A. Nieto de Castro, Y. Nagasaka, A. Nagashima, M.J. Assael, W.A. Wakeham; *Standard reference data for the thermal conductivity of water*; J. Phys. Chem. Ref. Data **24** (1995) p.1377-1381
- [7.] E.W. Lemmon and R.T. Jacobsen; *Viscosity and Thermal Conductivity Equations for Nitrogen, Oxygen, Argon, and Air*; Int. J. Thermophys. **25** (2004) 21

Table 8.3.2 *Indicative thermal conductivity values of common materials and material types. For literature values of thermal properties the reader is referred to the "Handbook of Chemistry and Physics".*

MATERIAL	THERMAL CONDUCTIVITY [W/(m·K)]
Insulating foam	< 0.1
Cotton	0.03
Leather	0.14
Plastics	0.08 – 0.3
Wood	0.05 – 0.5
Brick	0.6 - 1
Glass	0.9 – 1.5
Ceramics	>10
Stainless Steel	13-15
Plaster	0.2-0.7
Concrete	0.1 -1.8

Table 8.3.3 *Indicative values for the thermal conductivity of soils*

MATERIAL	THERMAL CONDUCTIVITY [W/(m·K)]
Soils in general	0.15 – 4.0
Soils, saturated	0.6 – 4.0
Sand, perfectly dry	0.15 – 0.25
Sand, moist	0.25 – 2.0
Sand, saturated	2.0 - 4.0
Clay, dry to moist	0.15 – 1.8
Clay, saturated	0.6 – 2.5
Soils with organic matter	0.15 – 2.0
Solid rocks	2.0 -7.0
Tuff (porous volcanic rock)	0.5 – 2.5

8.4 Calibration

It is in principle never necessary to adjust the thermal needle probe calibration. The thermal needle probe is calibrated during manufacturing and it is highly unlikely that the probe characteristic will deviate. Furthermore, in case the characteristic deviates due to degeneration or misuse of the probe, is it unlikely that a calibration as described below will give any improvement to the accuracy of the measurement.

Nonetheless, the system can be calibrated against a reference material with a known thermal conductivity either to verify that the system is functioning reliably or because it is required by certain standards (most notably ASTM D5934 and ASTM D5930). A list of common reference materials can be found in Section 8.4.1. Follow the calibration procedure described in Section 5.2. Take special care of the thermal and mechanical stability of the reference material and the probe. Work in a thermally stable environment. Avoid air flows due to open doors, windows or air conditioning. Avoid working in an area near a window where the setup is exposed to sunlight. This may cause an uncontrolled temperature change of the probe or calibration cylinder. The statistical uncertainty in the measured thermal conductivity should be less than 1 % for a calibration measurement to be of sufficient quality.

Compare the measured value for the thermal conductivity to the reference (literature) value for the thermal conductivity.

The ASTM D5934 and ASTM D5930 standards define a calibration factor C :

$$C = \frac{\lambda_{\text{reference}}}{\lambda_{\text{measured}}}$$

and require all subsequent measurement results to be multiplied by this factor. This means that the measurements are made relative to the reference material. In contrast the IEEE 442-2017 standard does NOT use a calibration factor. This means that those measurements are 'absolute' in the sense that they rely on:

- the calibration of the thermal needle probe's heater resistance R_L ,
- the thermal needle probe's thermocouple type, and
- the calibration of the thermocouple voltage and heater current measurement by the MCU.

For convenience the calibration factor C can be included in the heater resistance R_L , although it must be noted that the calibration factor describes the calibration of the system as a whole. Use the following formula to compute a new wire resistance $R_L^{(\text{new})}$ out of the known value of for the thermal conductivity $\lambda_{\text{reference}}$ of the reference material and the observed thermal conductivity $\lambda_{\text{measured}}$:

$$R_L^{(\text{new})} = C \cdot R_L^{(\text{old})} = \left(\frac{\lambda_{\text{reference}}}{\lambda_{\text{measured}}} \right) \cdot R_L^{(\text{old})}$$

where $R_L^{(\text{new})}$ is the newly calculated value for the heater resistance and $R_L^{(\text{old})}$ the

currently used heater resistance. Take the temperature dependence of the thermal conductivity of the reference material into account. E.g. for Hukseflux supplied CRC01 calibration reference cylinders:

$$\lambda_{\text{ref.}}(T) = \lambda_{\text{ref.}}(T = 0^\circ\text{C}) + a \cdot T$$

where $\lambda_{\text{ref.}}(T = 0^\circ\text{C})$ is the thermal conductivity of the reference material in W/(m·K) at zero degrees Celsius, a is the temperature coefficient of the thermal conductivity in W/(m·K²) and T is the temperature in °C. The thermal conductivity at zero degrees Celsius and the temperature coefficient can be found on the data sheet of the CRC01 calibration reference cylinder.

8.4.1 Commonly used reference materials

Table 8.4.1.1 lists some commonly used thermal conductivity reference materials.

TPSYS20 is supplied with a reference material container. The container can be used to calibrate the thermal needle probe against glycerol. The reference material container contains polyester fibres to inhibit diffusion. Glycerol is not included and must be purchased separately. Glycerol is available from most pharmacies and can also readily be purchased from chemical suppliers such as: Merck Millipore/SIGMA-ALDRICH® or Fisher Scientific.

Users are responsible for obtaining and observing the material safety data sheet (MSDS) from their supplier of glycerol.

As an alternative, Hukseflux Thermal Sensors supplies CRC01 calibration reference cylinders containing a PMMA reference material (see Figure 8.4.1.1). The PMMA reference material is fabricated in a special manner to ensure an isotropic and homogeneous thermal conductivity.

Table 8.4.1.1 Commonly used thermal conductivity reference materials for the calibration of thermal needle probes (continued on next page)

Reference material	Notes
Agar gel	Agar gel is recommended as a reference material in the ASTM D5334-14 standard. The thermal conductivity of agar gel may be assumed equal to that of water. Use of agar gel instead of water prevents convection.
Glycerol	Glycerol is recommended as a reference material in the ASTM D5334-14 standard. Glycerol must be at least 96 % pure. If the glycerol is not pure the thermal conductivity will deviate. Especially the water content of glycerol will affect the value of the thermal conductivity.

	TPSYS20 is supplied with a reference material container that can be filled with glycerol. The container is supplied with polyester fibres to inhibit convection.
Polymethylmethacrylate (PMMA)	Hukseflux supplies CRC01 calibration reference cylinders containing a PMMA reference material.
Polydimethylsiloxane (PDMS)	PDMS is recommended as a reference material in the ASTM D5930-17 standard. Depending on viscosity, consider using fibres to inhibit convection.



Figure 8.4.1.1 A CRC01 calibration reference cylinder for calibrating TP02 and TP08 thermal needle probes

8.5 Using the external trigger input

The external trigger input can be used to trigger the **Start**, **Start when stable** and **Stop** button by means of an externally generated trigger pulse. This can be useful for automation purposes where the system is part of a larger setup. E.g. when the probe is placed in an oven or climate chamber to perform measurements at an interval of different temperatures.

To use the external trigger input a BNC cable should be connected to the MCU. The external trigger pulses must meet the specifications listed in the specifications chapter. To arm the external trigger input, on the **MCU settings** tab in the **External trigger** box click the **Trigger setting** dropdown box and select the desired trigger setting: **Start**, **Start when stable** or **Stop**. The behaviour is similar to clicking the corresponding buttons in the web interface.

To disarm the trigger in the **External trigger** box, click the **Trigger setting** dropdown box and select **Off**. When the trigger is not being used it is recommended to disarm the trigger to prevent accidental triggering, which could disrupt measurements.

The trigger input contains a 100 k Ω pull-up resistor to 5 V. This allows a momentary push button (not included) to be connected to the trigger input.

When using the external trigger, observe the maximum input voltage and the minimum trigger pulse width as specified in Chapter 3.

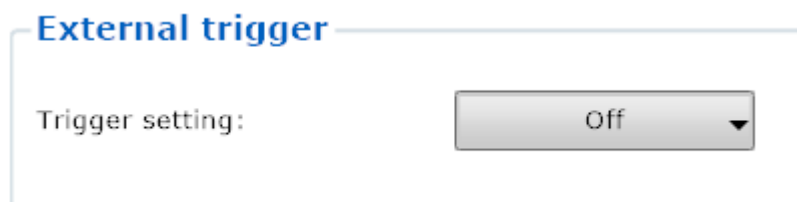

Figure 8.5.1 *The External trigger box on the MCU settings tab*

NOTICE

When using the external trigger input, do not exceed maximum input voltage. Exceeding the maximum trigger input voltage may permanently damage the TPSYS20 MCU.

8.6 TPSYS20 field use

TPSYS20 is primarily intended for laboratory use. With some additions however, TPSYS20 could be used in field experiments. For field use TPSYS20 could be powered from a battery and operated using a portable laptop or a Campbell Scientific CR1000KD Keyboard/Display (see Figure 8.6.1). The battery and CR1000KD are not included and must be purchased separately. This appendix explains how to connect TPSYS20 to a battery and how to operate TPSYS20 using a Campbell Scientific CR1000KD Keyboard Display.

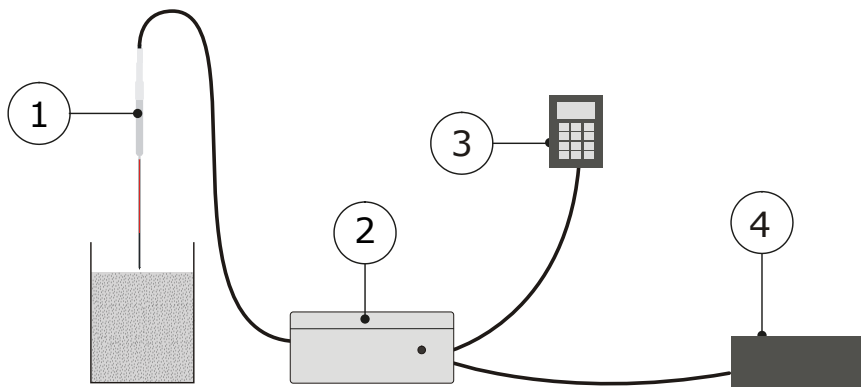

Figure 8.6.1 For field use, the TPSYS20 MCU (2) could be powered from a battery (4) and operated using either a portable laptop or a Campbell Scientific CR1000KD Keyboard/Display (3).

8.6.1 Powering TPSYS20 from a battery

TPSYS20 can be powered from a 12V battery (e.g. Campbell Scientific PS200 Smart 12 V Power Supply with Charging Regulator and 7 Ah Rechargeable Battery). When powering TPSYS20 from a battery the maximum current drawn by the MCU as specified in Chapter 3 must be taken into account when selecting a battery and considering a suitable wire gauge (AWG). To power TPSYS20 from a battery, the battery must be connected to the TPSYS20 MCU using a Bulgin Standard Buccaneer®, PX0736/S, 2 pole connector with sockets. The connector wiring is explained in Table 8.6.1.1.

The battery and connector must be purchased separately. Hukseflux Thermal Sensors does not supply batteries or connectors to power TPSYS20.

NOTICE

Do not apply a reverse voltage to the TPSYS20 MCU power input. Reversing the polarity of the TPSYS20 MCU power input may permanently damage the MCU.

Table 8.6.1.1 *Wiring of the battery to a Bulgin Standard Buccaneer®, PX0736/S, 2 pole connector with sockets*

Battery	Recommended wire colour	Bulgin Standard Buccaneer®, PX0736/S
12V	Red	L
G	Black	N

8.6.2 Using TPSYS20 with a Campbell Scientific CR1000KD Keyboard/Display

For field use TPSYS20 can be operated using a portable laptop or a Campbell Scientific CR1000KD Keyboard/Display (see Figure 8.6.2.1). The CR1000KD provides the user with a minimal user interface. Therefore, if possible, the use of a laptop is preferred. If the CR1000KD is to be used to operate TPSYS20 it is strongly recommended that the user becomes familiar with the CR1000KD before performing field measurements. The Campbell Scientific CR1000KD Keyboard/Display is not included with TPSYS20 and may be purchased separately.

To use the Campbell Scientific CR1000KD Keyboard/Display it has to be connected to the DB9 connector labelled 'CS I/O' on the TPSYS20 MCU. It may be necessary to switch the TPSYS20 MCU power off and back on before the CR1000KD Keyboard/Display will function properly.



Figure 8.6.2.1 *The Campbell Scientific CR1000KD Keyboard/Display can be used to operate the system without a PC.*

When connected to TPSYS20 the CR1000KD will generate the following menu tree:

- Thermal needle probe
 - Probe model {R}

- Serial number {R}
- Heater resistance {R}
- Change parameters
 - Probe model {W} [TP02, TP08]
 - Serial number {W}
 - Heater resistance {W}
 - Accept changes {W} [YES, NO]
- Calibration Ref.
 - Thermal cond. at 0 deg. C {R}
 - Temp. coeff. {R}
 - Change parameters
 - Material {W} [AGAR, GLYCEROL, POLYMETHYLMETACRYLATE, POLYDIMETHYLSILOXANE, CUSTOM_REFERENCE]
 - Thermal cond. at 0 deg. C {W}
 - Temp. coeff. {W}
 - Accept changes {W} [YES, NO]
- Measurement param.
 - Next experiment id {R}
 - Specimen description {W}
 - Waiting time {W}
 - Heating time {W}
 - Use cooling data {W} [YES, NO]
 - Heater power {W}
- Controls
 - Start when stable {W} [YES, NO]
 - Start {W} [YES, NO]
 - Start calibration {W} [YES, NO]
 - Stop {W} [YES, NO]
- Live data
 - Temp. Diff. {R}
 - Heater Power {R}
 - Base temp. {R}
 - Hot junction {R}
 - Cold junction {R}
- Results
 - Experiment id {R}
 - Specimen description {R}
 - Waiting time {R}
 - Heating time {R}
 - Includes cooling data {R}
 - Heater power {R}
 - Statistical uncertainty {R}
 - Thermal conductivity {R}
 - Statistical uncertainty {R}
 - All remarks
 - R_Re {R}
 - R_heat_time {R}
 - R_heater_power {R}
 - R_P_stability {R}
 - R_P_Low {R}
 - R_T_stability {R}

- R_sig_stability_heating {R}
- R_sig_stability_cooling {R}
- R_lambda_heating_cooling {R}
- Calibration summary
 - Measured value {R}
 - Reference value {R}
 - Relative deviation {R}
 - Calibration result {R}
- Advanced
 - Temp. stability criterion {W} [0.005, 0.010, 0.050]
 - Trigger {W} [TRIGGER_OFF, TRIGGER_START_WHEN_STABLE, TRIGGER_START, TRIGGER_STOP]
- Display settings
 - Turn Off Display
 - Back Light
 - Contrast Adjust
 - Display Timeout
 - Timeout

Legend

{W} – writeable, i.e. the user can adjust this

{R} – read only, the user can read this but not adjust this

[] – list of selectable options

The menu can be navigated using the ▲, ▼, ◀, and ▶ keys on the CR1000KD. To select a menu item use the **Enter** ↵ key. The CR1000KD top level menus largely mimic the group boxes on the web interface. Changing the thermal needle probe parameters or the calibration reference parameters requires the user to:

1. navigate into the submenu 'Change parameters';
2. enter the new values in the corresponding fields; and finally
3. navigate to 'Accept changes' and select YES.

For more information about the Campbell Scientific CR1000KD Keyboard/Display please refer to <https://www.campbellsci.com/cr1000kd>.

8.7 Thermal needle probe wiring

TP02 and TP08 thermal needle connectors are connected to TPSYS20 using a Fischer S 104 A055-130, 9 pin, male connector with internal part E3 104.2/6.7 + B. The wiring scheme is listed in Table 8.7.1.

Table 8.7.1 *Wiring of the Fischer connector. Note that TP08 does not have a tip thermocouple.*

Connector pin no.	Wire colour	Thermal needle probe
1	Black	Heater [+]
2	Black	Heater [-]
3	White	Thermocouple difference [-] Tip thermocouple [+]
4	Yellow with red sleeve	Central thermocouple [-] Tip thermocouple [-]
5	Yellow	Thermocouple difference [+] Central thermocouple [+]
6	White	Pt1000 current -
7	Red	Pt1000 current +
8	Red	Pt1000 sensing +
9	Not connected	Not in use (reserved for Pt1000 sensing -; for four instead of three terminal measurement)
Shield	Grey	

8.8 LoggerLink app

The Campbell Scientific LoggerLink Apps for iOS and Android can be used to communicate with the Campbell Scientific CR1000X datalogger in the TPSYS20 MCU. See: <https://www.campbellsci.com/loggerlink>. The LoggerLink Apps can be useful for finding the datalogger's IP address, setting the datalogger clock and checking the datalogger clock. It is not recommended to use the LoggerLink Apps to control or monitor thermal conductivity measurements made with TPSYS20.

To use the LoggerLink App the TPSYS20 MCU must be connected to your ethernet network.

8.8.1 Finding the datalogger's IP address

In the LoggerLink app, you can search for TPSYS20 on your network using the search function under 'TCP settings'.

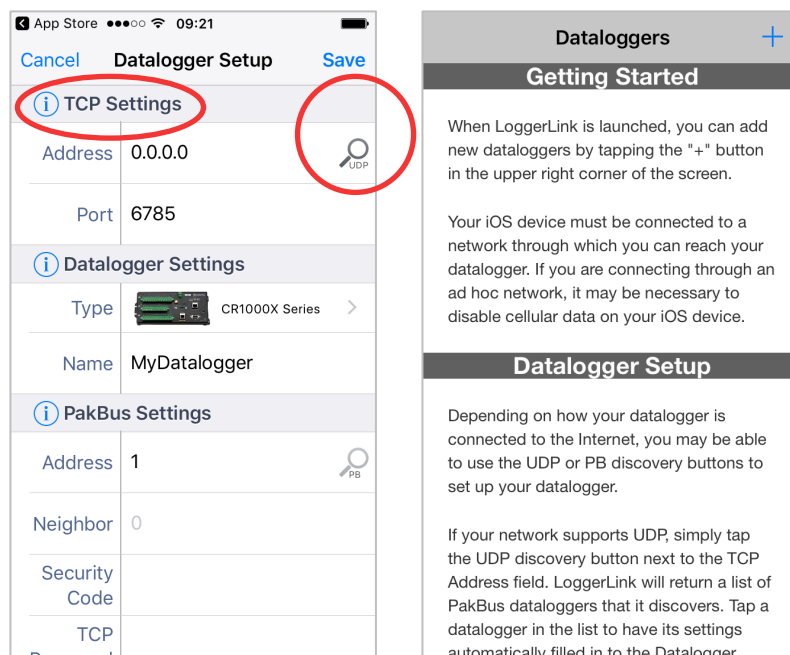

Figure 8.8.1.1 Using the LoggerLink app to find TPSYS20's IP address

8.8.2 Setting the datalogger clock

Connect to the TPSYS20 MCU using the Campbell Scientific LoggerLink app. In the **Status** menu, scroll down to the bottom and choose **Set Clock**. You can choose to set the clock to the server time, or set a time manually.

8.9 Campbell Scientific Device Configuration Utility

The Campbell Scientific Device Configuration Utility can be used for advanced troubleshooting or modifying the settings of the MCU. Some caution is advised however because the utility also allows users to delete or modify the TPSYS20 MCU software and web interface, which could render TPSYS20 MCU inoperable until the software has been reinstalled. The utility can be download from:

<https://www.campbellsci.com/downloads/device-configuration-utility>

8.9.1 Finding the IP address using direct Ethernet connection

When connected via direct Ethernet you can use the utility to find the IP address.

In the Device Configuration Utility, select **CR1000X Series** under the **Datalogger** options. Make sure to check the **Use IP Connection** box and click the ... button next to the **Communication Port** field. This shows the dataloggers and their IP address in the network.

When you have found the IP address of the TPSYS20, open your web browser and type the IP address in your address bar.

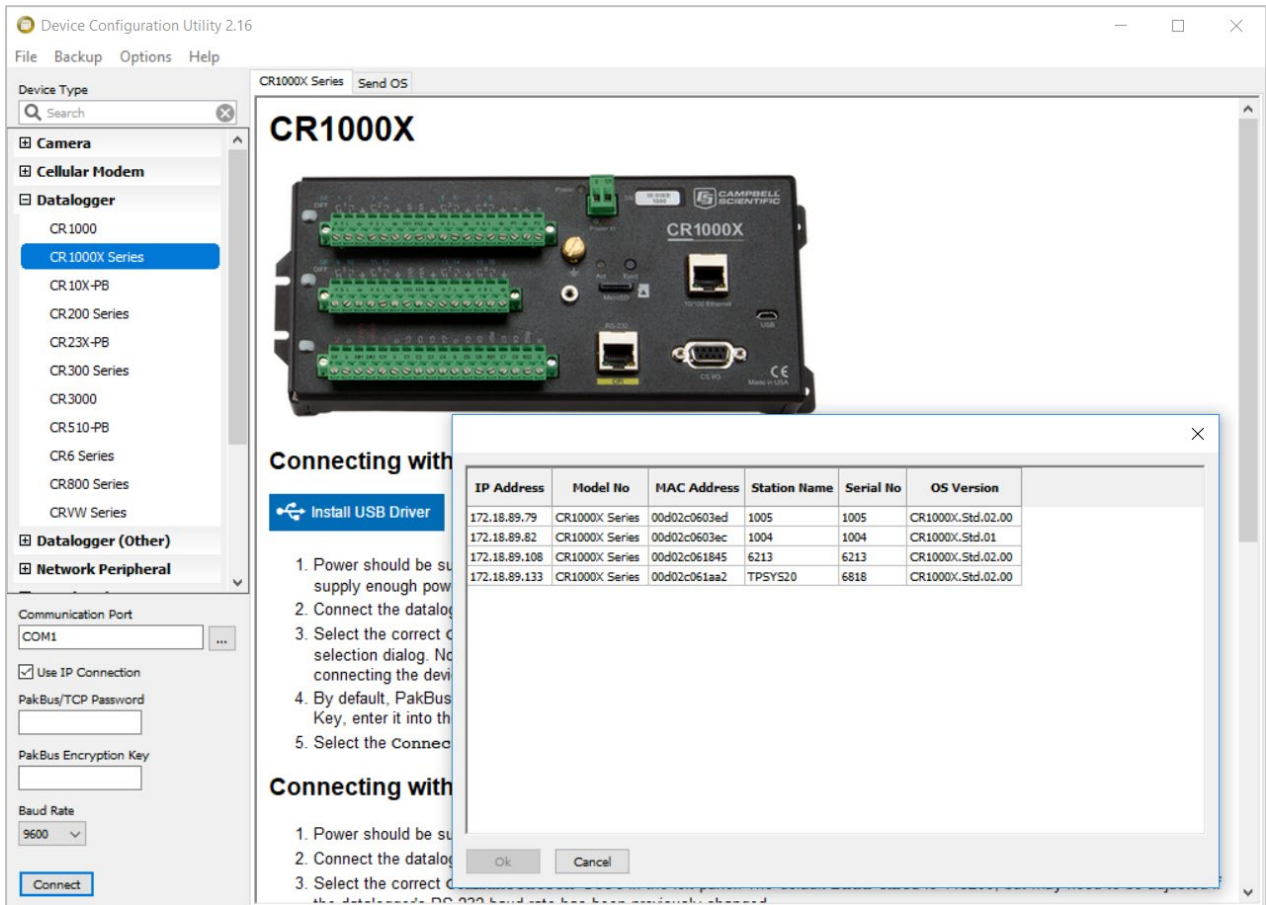

Figure 8.9.1.1 Using the Device Configuration Utility to find TPSYS20’s IP address

8.9.2 Installing drivers manually

Under **Datalogger**, select **CR1000X series** and click the **Install USB Driver** button, as illustrated in Figure 8.9.2.1

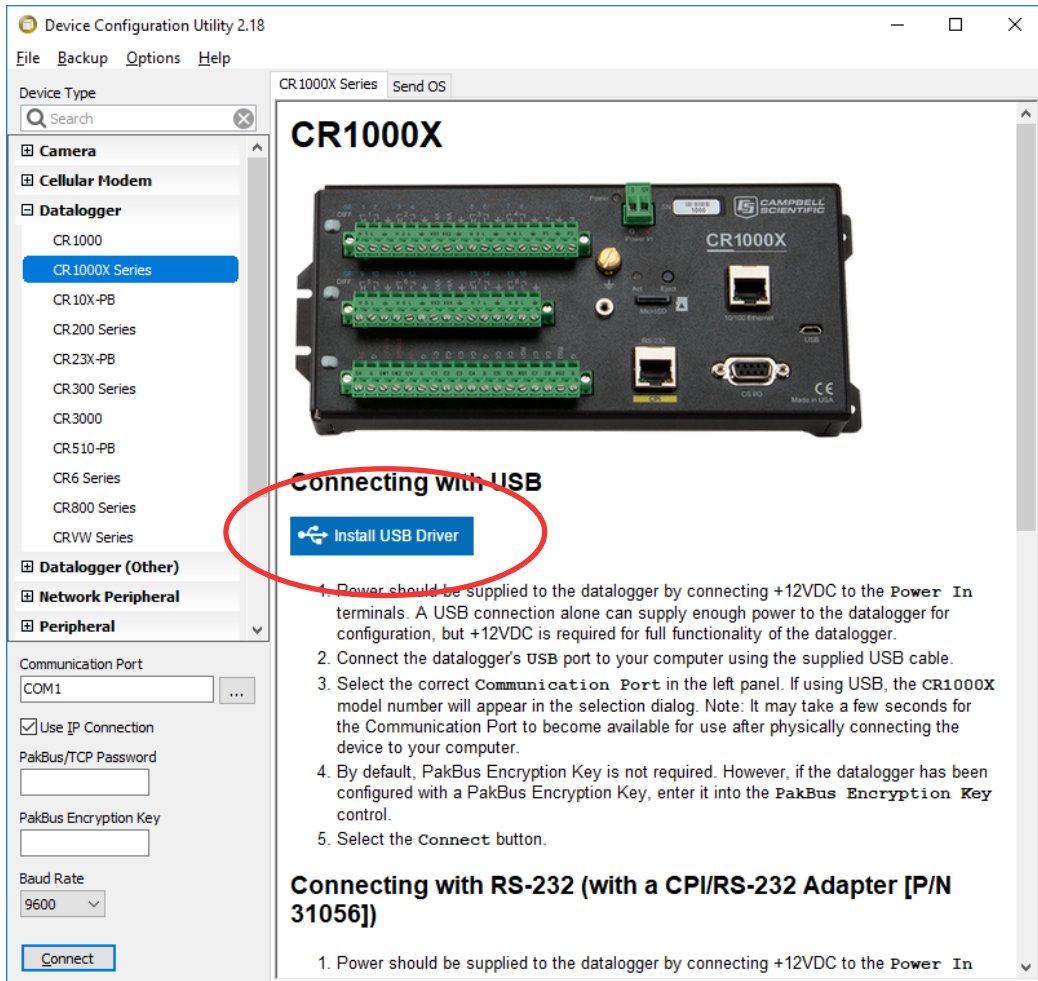

Figure 8.9.2.1 Using the Device Configuration Utility when drivers are not installed automatically

8.10 EU declaration of conformity



We, Hukseflux Thermal Sensors B.V.
Delftechpark 31
2628 XJ Delft
The Netherlands

in accordance with the requirements of the following directives:

2014/30/EU The Electromagnetic Compatibility Directive
2011/65/EU, The Restriction of Hazardous Substances Directive
(EU) 2015/863

hereby declare under our sole responsibility that:

Product model: TPSYS20
Product type: thermal needle probe with measurement and control system

has been designed to comply and is in conformity with the relevant sections and applicable requirements of the following standards:

Emission: IEC/EN 61326-1 (2013), Class B
Immunity: IEC/EN 61326-1 (2013)
Report: 20210178RPT01 and the addendum to this document



Eric HOEKSEMA
Director
Delft
25 May, 2021

